

# Honeywell

M9484 AND M9494 MODUTROL MOTORS ARE LOW VOLTAGE, REVERSING PROPORTIONAL CONTROL ACTUATORS FOR VALVES, DAMPERS AND AUXILIARY EQUIPMENT. THEY ARE ESPECIALLY DESIGNED FOR COMMERCIAL OR INDUSTRIAL OIL OR GAS BURNER CONTROL SYSTEMS.

- Replace M941 motors.
- Oil immersed motor and gear train for reliable performance and long life.
- Wiring box provides NEMA 3 weather protection.
- Actuator motor and circuitry operate from 24 volts AC. Models available with factory installed transformer, or internal transformer can be field added.
- Quick-connect terminals standard – screw terminal adapter available.
- Adapter bracket for matching shaft height of older motors is standard with replacement motors.
- Field adjustable stroke (90° to 160°) models available.
- Nominal timing of 30 seconds for 90° and 60 seconds for 160° stroke is standard. Other timings are available.
- Die-cast magnesium housing.
- Available accessories include valve and damper linkages, explosion proof housing, and auxiliary switches.
- Field addable interface modules can be mounted in wiring box to upgrade actuator to Series 70 (electronic) control.
- Models available with tapped output shaft.
- M9481, M9484 rated for 150 lb.-in. torque at standard timings.
- M9491, M9494 rated for 300 lb.-in. torque at 2 or 4 minute timings for 160° stroke.

## MODUTROL IV MOTORS

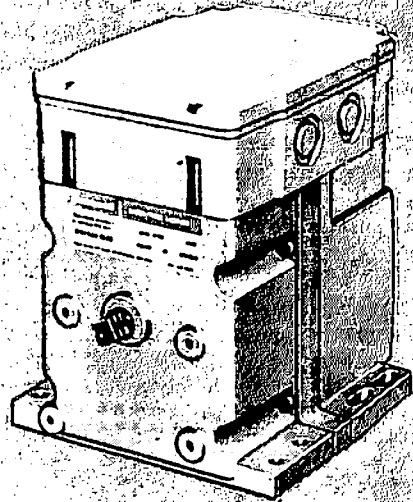

M9484, M9481  
M9494, M9491

# SPECIFICATIONS

## STANDARD MODELS

<b>M9484D,E,F M9494D</b>	
<b>Control Type</b> 94 is Series 90	<b>Suffix Letter</b> <b>D:</b> is adjustable stroke (90° to 160°) No auxiliary switches <b>E:</b> is adjustable stroke (90° to 160°) 1 auxiliary switch <b>F:</b> is adjustable stroke (90° to 160°) 2 auxiliary switches
<b>Power Rating</b> 8 is high torque 150 lb.-in. at standard timing 9 is high torque 300 lb.-in. at 2 or 4 min timing	
<b>Output Drive</b> 4 is dual-ended shaft, non-spring return 1 is single-ended shaft, non-spring return	

**NOTE:** Some motors furnished to equipment manufacturers will have no adapter bracket, a single-ended shaft and/or no wiring box.

**CONTROLLER TYPE:** Series 90 Control Circuit—135 ohm series 90 proportioning controller. Series 90 high or low limit controller with manual minimum position potentiometer (with a combined total resistance of up to 500 ohms) may also be used in the control circuit.

**MOTOR ROTATION:** Normally closed\*. The closed position is the limit of counterclockwise rotation as viewed from the power end of the motor. See Fig 2. Motor opens clockwise (as viewed from the power end). Motors are shipped in the closed position.

### ELECTRICAL RATINGS:

	VOLTAGE (V @ 50/ 60 Hz)	CURRENT DRAW (A)	POWER CONSUMPTION (W)
Without Transformer	24	0.8	18
With Internal Transformer	120	0.24	23
	208	0.14	23
	240	0.12	23

**STROKE:** Field adjustable from 90° to 160°. Start position of shaft changes with adjustment of stroke. (Midpoint of stroke remains fixed as stroke is adjusted, as shown in Fig. 2.) Stroke is adjusted by means of cams located in wiring compartment. (See Stroke Setting Procedure.) Motors are shipped with stroke set at 90°.

#### DEAD WEIGHT LOAD ON SHAFT:

Power or Auxiliary End—200 lb. [90.8 kg] maximum.  
 Maximum Combined Load—300 lb. [136 kg].

#### AMBIENT TEMPERATURE RATINGS:

Maximum—150° F [66° C] @ 25% duty cycle.  
 Minimum—minus 40° F [-40° C].

**CRANKSHAFT:** 3/8 inch [9.5mm] square  
 M9484, M9494 have double-ended shaft.  
 M9481, M9491 have single-ended shaft.

\*The normal position is the position the motor will assume with controller disconnected.

# ORDERING INFORMATION

**WHEN PURCHASING REPLACEMENT AND MODERNIZATION PRODUCTS FROM YOUR AUTHORIZED DISTRIBUTOR, REFER TO THE TRADELINE CATALOG OR PRICE SHEETS FOR COMPLETE ORDERING NUMBER.**

**IF YOU HAVE ADDITIONAL QUESTIONS, NEED FURTHER INFORMATION, OR WOULD LIKE TO COMMENT ON OUR PRODUCTS OR SERVICES, PLEASE WRITE OR PHONE:**

1. YOUR LOCAL HONEYWELL RESIDENTIAL AND BUILDING CONTROLS SALES OFFICE (CHECK WHITE PAGES OF PHONE DIRECTORY).
2. RESIDENTIAL AND BUILDING CONTROLS CUSTOMER SERVICE  
 HONEYWELL INC., 1885 DOUGLAS DRIVE NORTH  
 MINNEAPOLIS, MINNESOTA 55422-4386 (612)542-7500

(IN CANADA—HONEYWELL LIMITED/HONEYWELL LIMITEE, 740 ELLESMERE ROAD, SCARBOROUGH, ONTARIO M1P 2V9) INTERNATIONAL SALES AND SERVICE OFFICES IN ALL PRINCIPAL CITIES OF THE WORLD.

**AUXILIARY SWITCH RATINGS (amperes):**

M94XXE has 1 spdt switch.

M94XXF has 2 spdt switches.

ONE CONTACT <sup>a</sup>	120 V	240 V
Full Load	7.2	3.6
Locked Rotor	43.2	21.6

<sup>a</sup>40 VA pilot duty, 120/240 Vac on opposite contact.

DIMENSIONS: See Fig. 1.

UNDERWRITERS LABORATORIES INC. LISTED

File No. E4436; Guide No. XAPX.

CANADIAN STANDARDS ASSOCIATION CERTIFIED:

General Listing File No. LR1620, 400-E-)

TIMING		TORQUE IN lb.-in. [mm]	
90° STROKE MOTORS	160° STROKE MOTORS	NORMAL RUNNING TORQUE	BREAKAWAY TORQUE <sup>a</sup>
15 sec	30 sec	75 [8.5]	150 [17.0]
30 sec	1 min	150 [17.0]	300 [34.0]
1,2 min	2,4 min <sup>b</sup>	300 [34.0]	600 [68.0]

<sup>a</sup>Breakaway torque is the maximum torque available to overcome occasional large loads such as a seized damper or valve. MOTOR MUST NOT BE USED CONTINUOUSLY AT THIS RATING.<sup>b</sup>Stalling of 2,4 min motor will damage motor.**ACCESSORIES:**

ES650117 Explosion-proof Housing—Encloses motor for use in explosive atmospheres. Not for use with Q601, Q618, and Q455 Linkages. Order from Nelson Electric Co. Requires Honeywell 7617DM Coupling.

Q607 External Auxiliary Switch—Controls auxiliary equipment as a function of motor position.

Q605 Damper Linkage—Connects motor to damper. INCLUDES MOTOR CRANK ARM.

Q618 Linkage—Connects Modutrol motor to water or steam valve.

Q601 Bracket and Linkage Assembly—Connects Modutrol motor to water or steam valve.

Q100A,B Linkage—Connects Modutrol motor to but-

terfly valve. Requires adapter bracket packed with motor.

Q209E,F Potentiometer—Limits minimum position of motor.

Q68 Dual Control Potentiometer—Controls 1 through 9 additional motors.

Q181 Auxiliary Potentiometer—Controls 1 or 2 additional motors.

221455A Motor Crank Arm—Infinitely adjustable crank arm. Approximately 0.75 inches shorter than the 4074ELY crank arm, can rotate through downward position and clear base of motor without requiring use of adapter bracket.

220741A Screw Terminal Adapter—converts the standard quick-connect terminals to screws terminals.

Transformers—mounted internally, provide 24 Vac power to motor

198162JA—24 Vac; 50/60 Hz (for electrical isolation).

198162EA—120 Vac; 50/60 Hz.

198162GA—220 Vac; 50/60 Hz.

198162AA—120/208/240 Vac; 50/60 Hz.

Q7130A—Interface Module with selectable voltage ranges (4-7 Vdc, 6-9 Vdc, and 10.5-13.5 Vdc). Adapts motor to M71XX function.

Q7230A—Interface Module, selectable voltage or current control, with adjustable null and span. Adapts motor to M72XX function; 4 to 20 mA or 2 to 10 Vdc.

Q7330A—Interface Module, for W936 economizer applications. Adapts motor to M73XX function.

Q7630A—Interface Module, 3-wire 14-17 Vdc control with minimum position capability. Adapts motor to M76XX function.

4074BYK—Control up to 6 M91XX motors in unison from one Series 90 controller.

4074EAU—Drive 2 or 3 M91XX motors from a W973 Single-zone Logic Panel or W7100 Discharge Air Controller.

4074EDC—Drive one M91XX motor from a 4-20 mA Controller.

4074EED—Drive up to 4 M91XX motors from a 4-20 mA Controller.

221508A Resistor Board—Plugs onto quick-connects in wiring box of M91XX motor. Can be used in place of 4074BYK, EAU, EDC, or EED resistor kits (functions described above).

7616ADW Motor Crank Arm—Approximately 0.75 inches shorter than the 7616BR crank arm, can rotate through the downward position and clear base of motor without requiring use of adapter bracket.

## INSTALLATION

**WHEN INSTALLING THIS PRODUCT...**

1. Read these instructions carefully. Failure to follow them could damage the product or cause a hazardous condition.

2. Check the ratings given in the instructions and on the product to make sure the product is suitable for your application.

3. Installer must be a trained, experienced service technician.

4. After installation is complete, check out product operation as provided in these instructions.

**CAUTION**

1. Disconnect power supply before beginning installation to prevent electrical shock and equipment damage.
2. Never turn the motor shaft by hand or with a wrench—this will damage the motor.
3. Always conduct a thorough checkout when installation is complete.

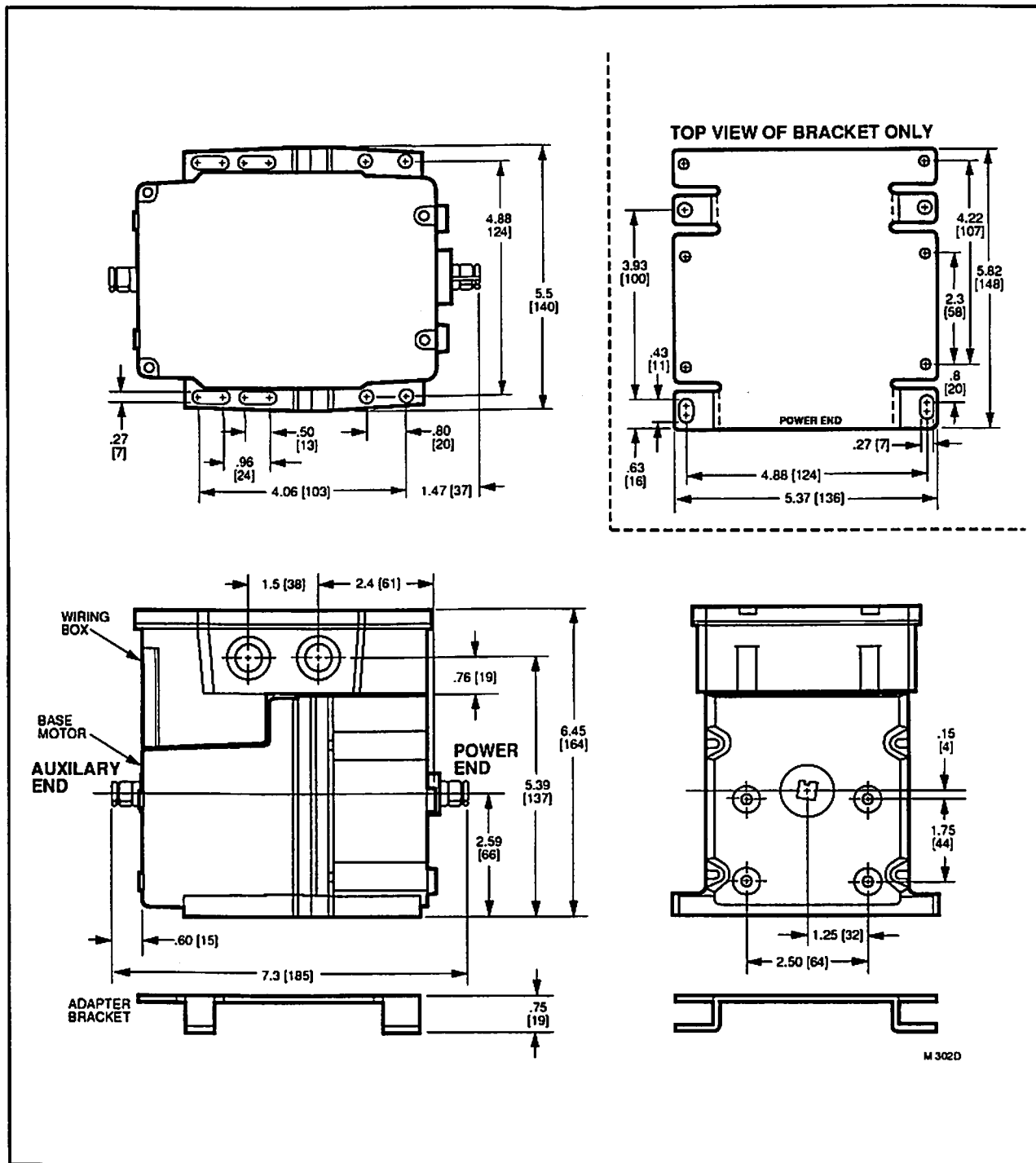

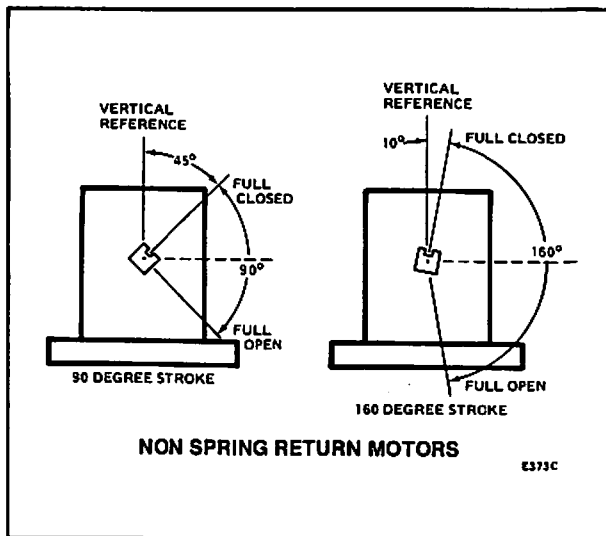

FIG. 2—LIMITS OF MOTOR ROTATION.

### ADAPTER BRACKET

The 220738A Adapter Bracket, positioned between the motor and the equipment, raises the shaft height of the M9484 motor by 0.75 inch to match that of the M941 motor. This is required on all valve linkage applications, Q607 External Auxiliary Switch applications, and on some damper linkage applications (either to provide clearance for the crank arm to rotate through the downward position, or to allow the damper linkage to reach the shaft).

To mount the motor with the bracket:

1. Mount the bracket to the equipment with existing or standard bolts.

2. Mount the motor to the bracket using the bolts provided into the threaded holes of the bracket (see Fig. 3).

For valve linkage applications, the bracket should first be mounted to the linkage (see Fig. 4). The bracket then provides a convenient base on which the motor can be positioned. After the motor shaft is aligned to the linkage, it can then be attached to the bracket with the 4 bolts provided. These bolts go through the inner set of holes in the motor flange and into the threaded holes of the bracket.

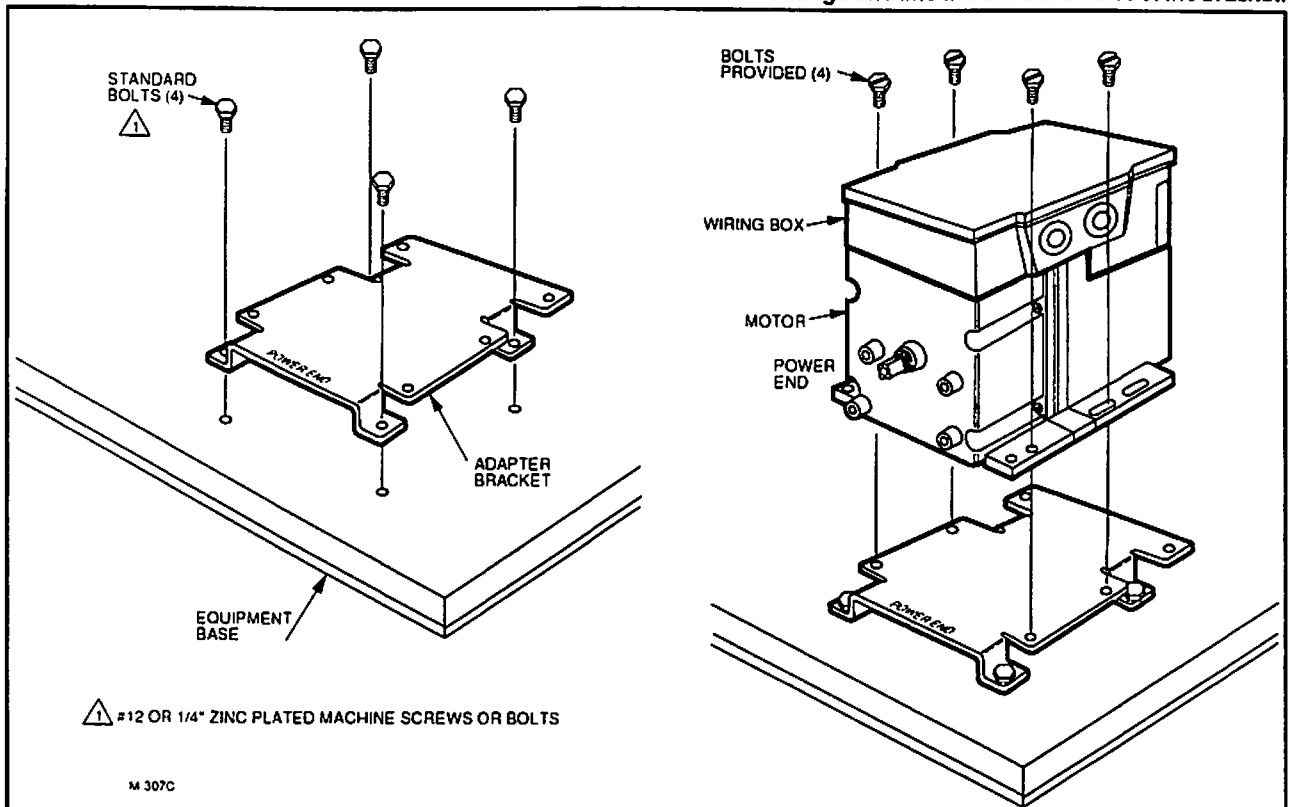

FIG. 3—MOUNTING MOTOR WITH 220738A ADAPTER BRACKET. The bracket is first mounted to the equipment with standard bolts. The motor is then mounted to the bracket using the bolts provided with the bracket, which thread into the threaded bracket holes.

### DAMPER LINKAGES

A 220738A Adapter Bracket is packed with replacement motors. Use of this bracket is optional for many damper applications but may be needed in damper applications requiring the crank arm to rotate through the bottom plane of the actuator. If the bracket is not used in a replacement application, the damper linkage will have to be adjusted to the new shaft position.

The motor comes without a crank arm. The crank arm is included in the Q605 linkage or may be ordered separately (see Accessories).

For detailed instructions on the assembly of specific linkages, refer to the instruction sheet packed with each

linkage. In general, however, check the following points of operation when installing a motor and linkage.

1. Linkages for valves and louver type dampers should be adjusted so that the damper or valve moves through only the maximum required distance when the motor moves through its full stroke.

2. With modulating control, maximum damper opening should be no more than 60°. Little additional airflow is provided beyond this point.

3. The motor must be stopped at the end of its stroke by the limit switch and must not be stalled by the damper or valve. The motor will be damaged if it is not permitted to complete its full stroke.

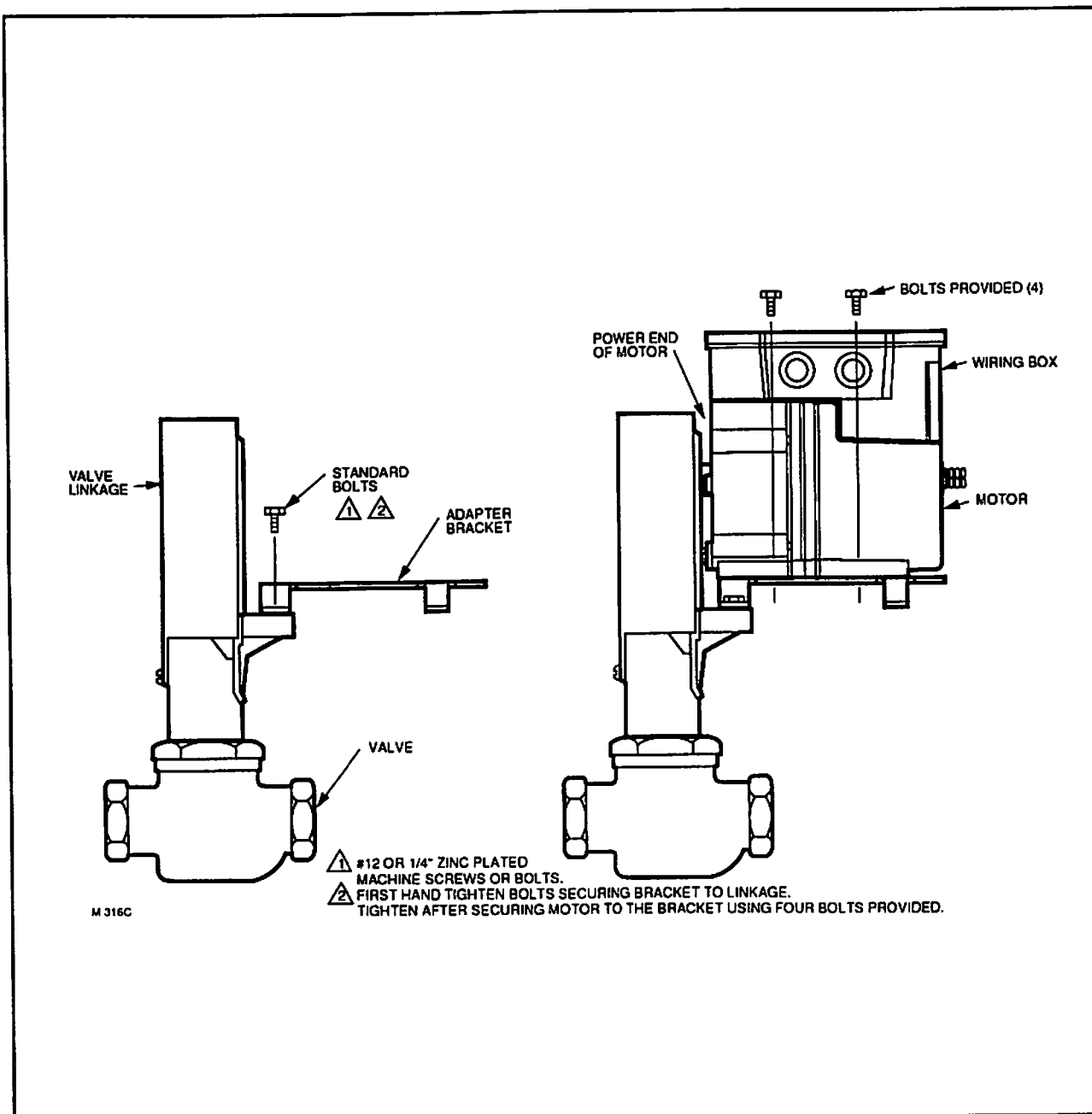

FIG. 4—MOTOR MOUNTING ON VALVE LINKAGE.

4. Do not exceed the motor ratings in any installation.
5. Do not turn motor shaft manually or with a wrench—this will damage the motor.

**VALVE LINKAGES**

The 220738A Mounting Bracket must be used with the Q100, Q601 and Q618 linkages in all valve applications.

**WIRING**

Disconnect power supply before wiring to prevent electrical shock or equipment damage. All wiring must agree with applicable codes, ordinances, and regulations.

A transformer is required to supply 24 Vac power to the motor. Make sure that the power requirements stamped on the motor correspond to the characteristics of the power supply.

Figs. 5 and 6 show internal schematics. The motor terminals are quick-connects located on top of the printed circuit board shown in Fig. 7. A screw terminal adapter is standard on all Trade models and also may be added to all models. Access to the wiring compartment is gained by removing the 4 screws in the top of the wiring box and lifting off the cover.

**WIRING BOX**

When used with liquid-tight conduit connectors, the wiring box provides NEMA 3 weather protection for the motor. The box also provides knockouts for wiring conduits and encloses terminals. The wiring box, standard with replacement motors, is required for housing an internal transformer, internal auxiliary switches or Series 70 Interface Modules.

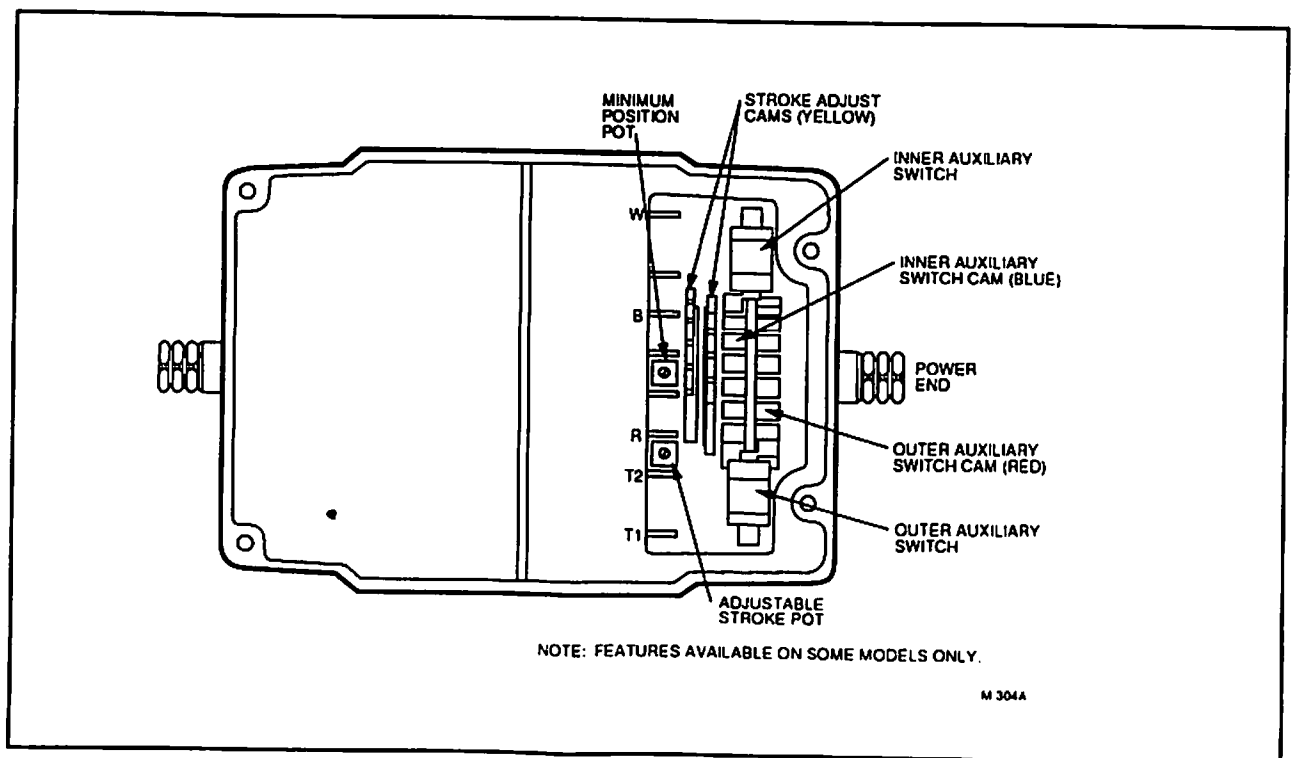
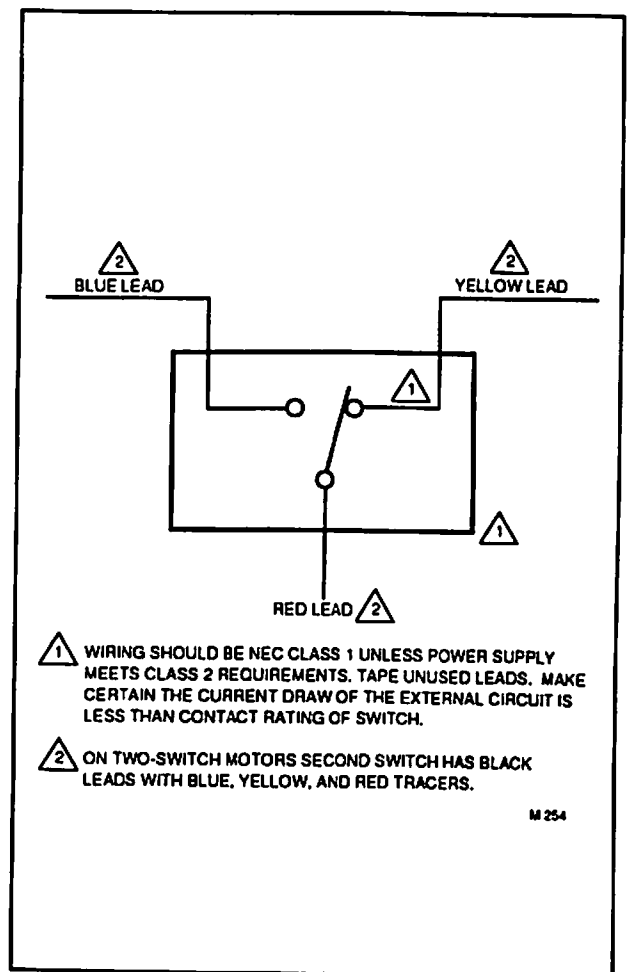
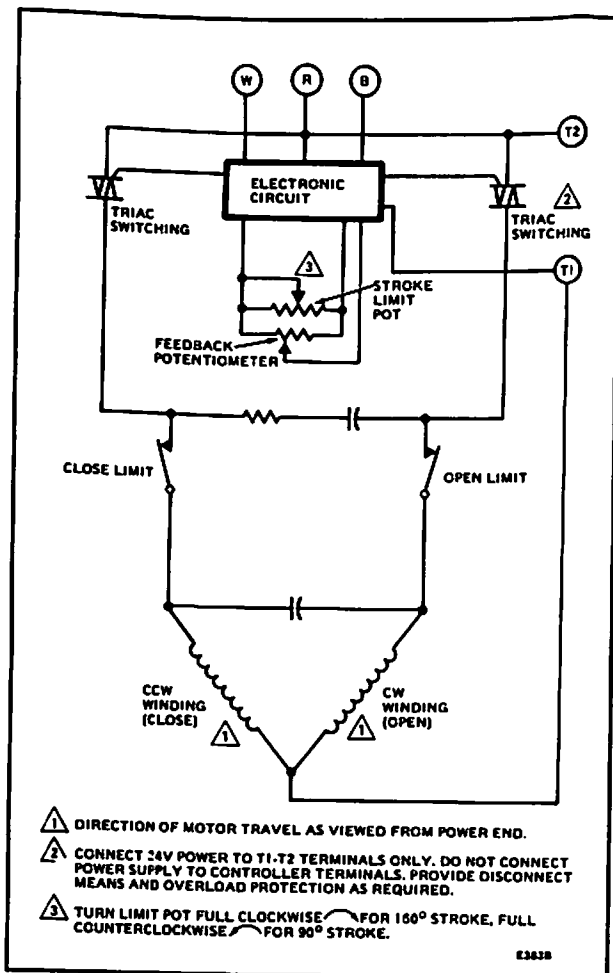

## AUXILIARY SWITCH CONNECTIONS

### CAUTION

Disconnect all power supplies to de-energize the auxiliary switches before servicing.

The M9484E has 1 internal auxiliary switch. The switch wires are color-coded as follows: solid yellow—normally closed (N.C.); solid red—common (COM.); solid blue—normally open (N.O.).

The M9484F has 2 internal auxiliary switches which may be used to prove low fire and high fire positions.

1. To prove low fire use red (common) and yellow wires connected to outer (left) switch. This switch makes red to yellow and breaks red to blue as motor closes.

2. Wires connected to the inner (right) switch are black with colored tracers. To prove high fire, use red tracer (common) and blue tracer wires. The right switch makes red tracer to blue tracer and breaks red tracer to yellow tracer as motor opens.

Color coding and switching action are tabulated below to aid the installer.

### SWITCH/CAM COLOR-CODING:

TABLE 1

SWITCH LOCATION <sup>a</sup>	CAM ASSEMBLY LOCATION <sup>a</sup>	CAM COLOR CODE	SWITCH WIRES <sup>b</sup>	
			COLOR	DESIGNATION
Left	Outer	Red	Solid Yellow Solid Red Solid Blue	Normally Closed (N.C.) Common (COM.) Normally Open (N.O.)
Right	Inner	Blue	Yellow Tracer Red Tracer Blue Tracer	Normally Closed (N.C.) Common (COM.) Normally Open (N.O.)

<sup>a</sup>Viewed from power end of motor.

<sup>b</sup>See Fig. 6.

### SWITCHING ACTION:

TABLE 2



SWITCH LOCATION <sup>a</sup>	NORMAL FUNCTION	MAKES	BREAKES	CAM POSITION <sup>b</sup>	MOTOR POSITION
Left	Proves Low Fire Position	Red to Yellow	Red to Blue	High portion of cam not in Contact with Cam follower.	Closing
Right	Proves High Fire Position	Red Tracer to Blue Tracer	Red Tracer to Yellow Tracer	High portion of cam in Contact with Cam follower.	Opening

<sup>a</sup>Viewed from power end of motor.

<sup>b</sup>See Fig. 9

## SETTINGS AND ADJUSTMENTS

### STROKE SETTING

On M94XXD,E,F motors, stroke is field adjustable and can be set from 90° to 160°. Motors are shipped in 90° position. In order to set stroke, both mechanical and electrical adjustments are required. The mechanical adjustments (cams) establish the full open (clockwise, ) as viewed from the power end) and full closed (counterclockwise, ) positions of the motor shaft. The electrical adjustment (trim pot) provides sufficient total stroke angle to ensure that cams will actuate both limit switches.

### STROKE SETTING PROCEDURE

See Fig. 8.



### CAUTION

Detach linkage from motor before adjusting stroke.

### BEFORE SETTING STROKE:

1. Remove top cover from motor.
2. Disconnect controller from motor.
3. Connect R,B,W terminals on 135 ohm potentiometer (Q209 or S963) to matching terminals on motor.

### SETTING 160° STROKE (Fig. 8):

1. Turn stroke pot fully clockwise .
2. Drive motor to mid-position using 135 ohm pot (Q209 or S963), or by jumpering B-R-W.
3. Insert 1/8 in. screwdriver blade into slot on inner yellow cam and MOVE TOP OF SCREWDRIVER as far as possible counterclockwise  (viewed from power end). Repeat in successive cam slots until inner cam is against counterclockwise  stop.



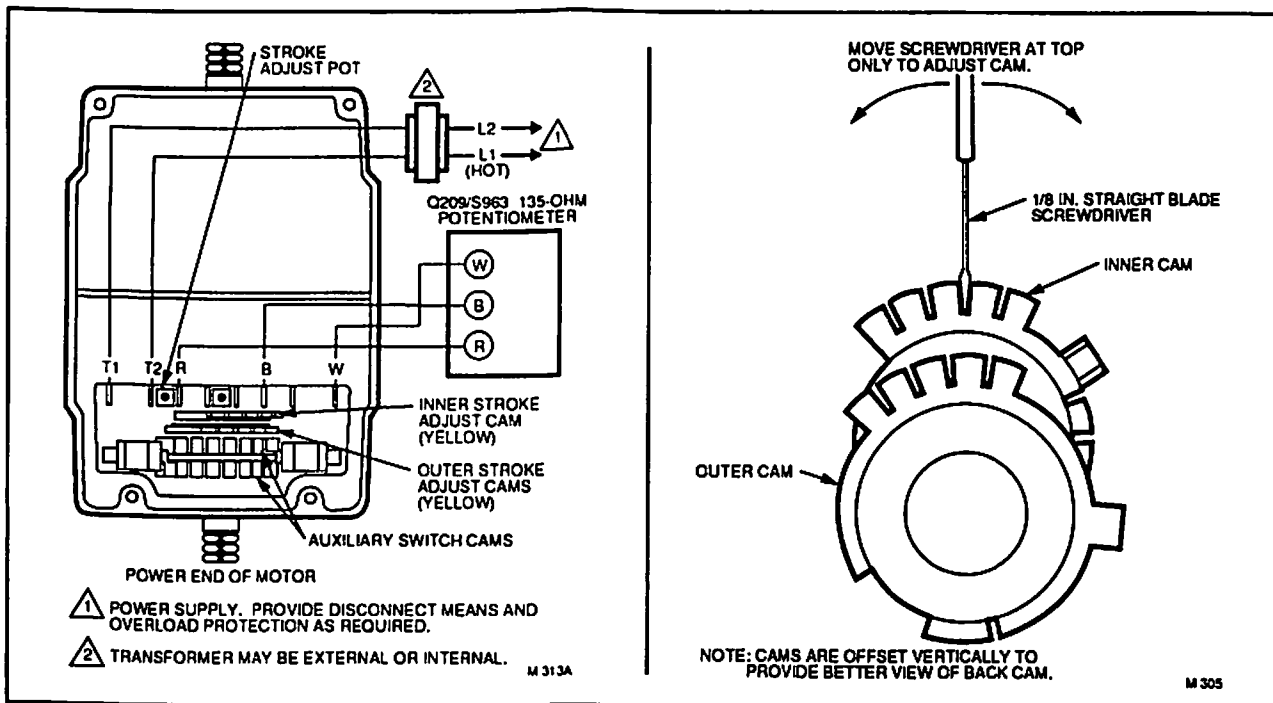

FIG. 8—STROKE ADJUSTMENT SETUP.

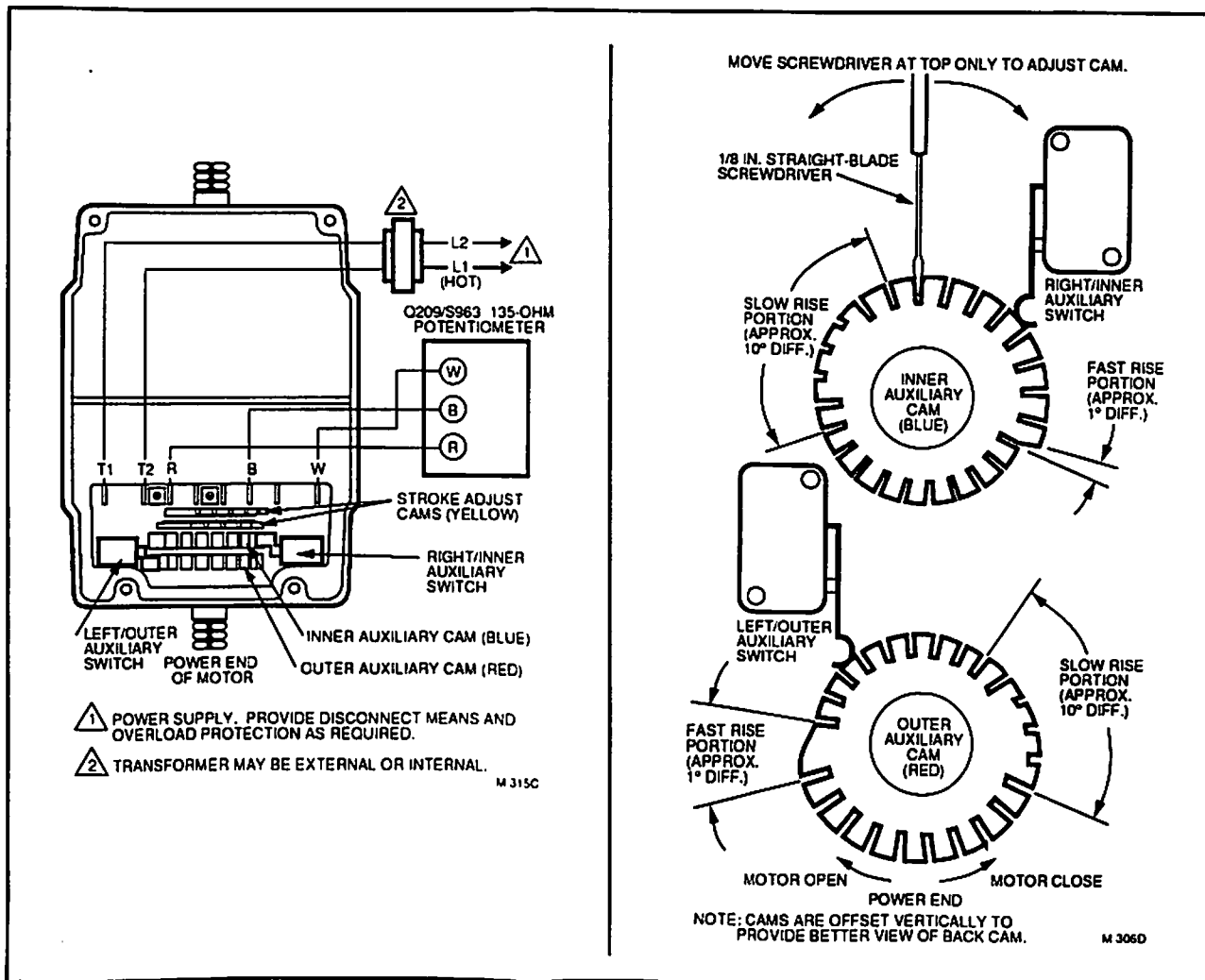



FIG. 9—AUXILIARY SWITCH ADJUSTMENT SETUP.

### IMPORTANT



Set cams by moving top of screwdriver only. Pressing screwdriver against sides of cam slots could cause damage to motor end switches.

4. Insert 1/8 in. screwdriver blade into slot on outer yellow cam and MOVE TOP OF SCREWDRIVER as far as possible clockwise . Repeat in successive cam slots until outer cam is against clockwise  stop.

NOTE: Excessive force will damage cam stop on hub.

5. Check motor stroke before connecting linkage.
6. Disconnect 135 ohm pot, reconnect controller, replace top cover on motor.
7. Attach linkage to motor.

### SETTING 90° STROKE (Fig. 8):

1. Turn stroke pot fully counterclockwise .
2. Drive motor to mid-position, using 135 ohm pot (Q209 or S963), or by jumpering B-R-W.
3. Insert 1/8 in. screwdriver into slot on inner yellow cam and MOVE TOP OF SCREWDRIVER as far as possible clockwise  (viewed from power end). Repeat in successive cam slots until inner cam is against clockwise stop.

NOTE: Excessive force will damage cam stop on hub.

4. Insert 1/8 in. screwdriver blade into slot on outer yellow cam and MOVE TOP OF SCREWDRIVER as far as possible counterclockwise . Repeat in successive cam slots until outer cam is against counterclockwise stop.



NOTE: Excessive force will damage cam stop on hub.

5. Check motor stroke before connecting linkage.
6. Disconnect 135 ohm pot, reconnect controller, replace top cover on motor.
7. Attach linkage to motor.

### AUXILIARY SWITCHES

The auxiliary switches in M9484E,F motors are actuated by adjustable cams. The cams are mounted on the motor shaft at the power end of the motor. The settings of the cams determine the point in motor shaft rotation at which the auxiliary equipment will be switched on or off. These cams can be set to actuate switches at any angle within the stroke of the motor. Also each cam provides a fast rise portion for switching (1° differential) and a slow rise portion for slow switching (10° differential).





Switching action and color coding are shown in Tables 1 and 2 on page 8.

Motors with factory added auxiliary switches are shipped in the closed position (counterclockwise , as viewed from power end) with auxiliary cams set to actuate switches 30° from the closed position, and to provide 1° differential. With motor in closed (full counterclockwise ) position, auxiliary switch breaks R-B.

### IMPORTANT

Do not turn motor shaft by hand or with a wrench as damage to the gear train and circuit board stroke limit contacts will result.

### AUXILIARY SWITCH SETTING PROCEDURE (Fig. 9)

1. Remove top cover from motor to gain access to motor terminals and cam adjustments.
2. Disconnect controller from motor and connect 135 ohm manual potentiometer with R-W-B terminals on pot connected to corresponding terminals on motor (Fig. 9).
3. Adjust 135 ohm pot so that motor shaft turns to position where auxiliary equipment is to be switched.
4. Insert a 1/8 in., straight-blade screwdriver into slot on cam associated with selected auxiliary switch. The inner (blue) cam actuates the inner (right) switch, the outer (red) cam actuates the outer (left) switch. MOVE TOP OF SCREWDRIVER to set cams.
5. For switch differential of 1°, check continuity of auxiliary switch R-B contacts and rotate cam as follows:
  - a. If contacts are open, rotate cam clockwise  until R-B contacts close.
  - b. If contacts are closed, rotate cam counterclockwise  until R-B contacts open.
6. For switch differential of 10°, check continuity of auxiliary switch R-B contacts and rotate cam as follows:
  - a. If contacts are open, rotate cam counterclockwise  until R-B contacts close.
  - b. If contacts are closed, rotate cam clockwise  until R-B contacts open.
  - c. Final adjustment in the proper direction should be made to obtain contact make or break at the desired position.
7. Check for proper differential and switching of auxiliary equipment by running motor through full stroke (in both directions), using 135 ohm pot. Repeat adjustment if necessary.
8. Disconnect 135 ohm pot, reconnect controller, replace top cover on motor.

NOTE: If differential is changed from 1° to 10°, the switching action is reversed, thus: switch contacts R-B make and R-W break on a counterclockwise (closed) rotation.

## OPERATION AND CHECKOUT

### MODULATING SERIES 90 CIRCUIT

The potentiometers, one in the controller and one in the motor, along with resistor network, form a bridge circuit. As long as the value of the controlled medium remains at the controller set point, the circuit is balanced, and the motor does not run.

When the value of the controlled medium changes, the potentiometer wiper in the controller is moved, which unbalances the bridge circuit. This unbalance is amplified, and energizes Triac switching to run the motor in the direction necessary to correct the change in temperature or pressure. The motor turns the feedback potentiometer to rebalance the circuit and stop the motor.

### CONNECTION DIAGRAMS (Figs. 10-13)

These motors are designed for use in series 90 proportioning control circuits employing a 135 ohm series 90 controller. Series 90 high or low limit controls or manual minimum position potentiometers may also be used in the control circuit.

The M9484 can also be used with some electronic controllers which provide a 4-20 mA control output. It is necessary to use a resistor kit (4074EED for controlling up to 6 motors) or Q7230 Interface Module to interface to the 4-20 mA source.

The standard series 90 controller has R, W, and B terminals. As the controller reduces R to W resistance, the motor will drive closed (CCW as viewed from the power end).

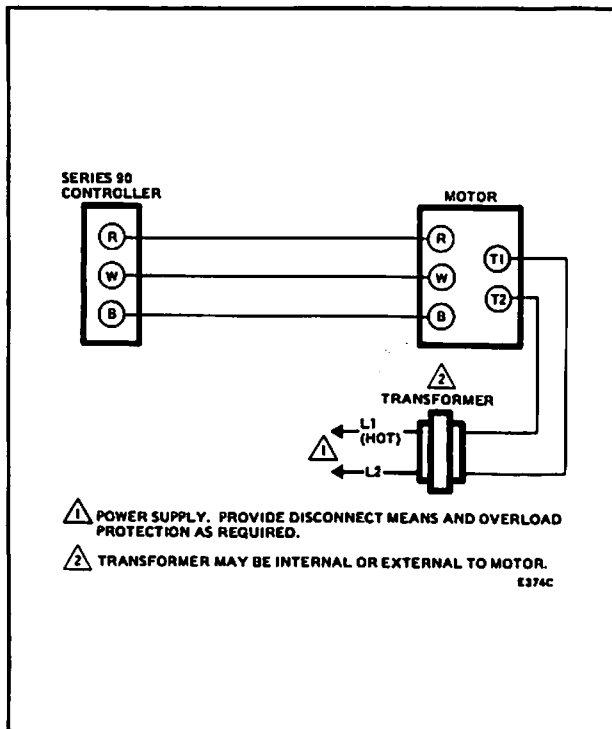

FIG. 10—CONNECTIONS TO SERIES 90 CONTROLLER.

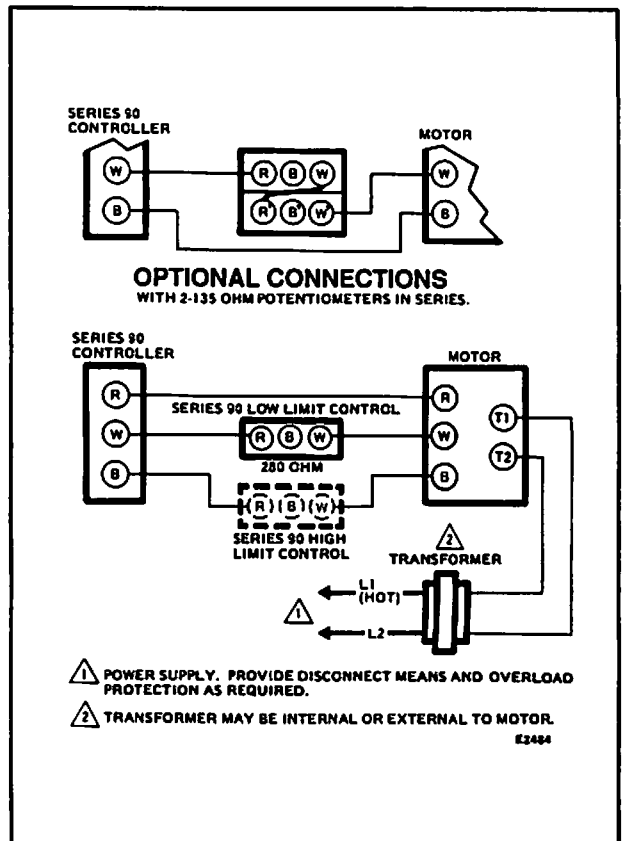

FIG. 11—MOTOR USED WITH A SERIES 90 CONTROLLER AND A SERIES 90 LOW OR HIGH LIMIT CONTROL.

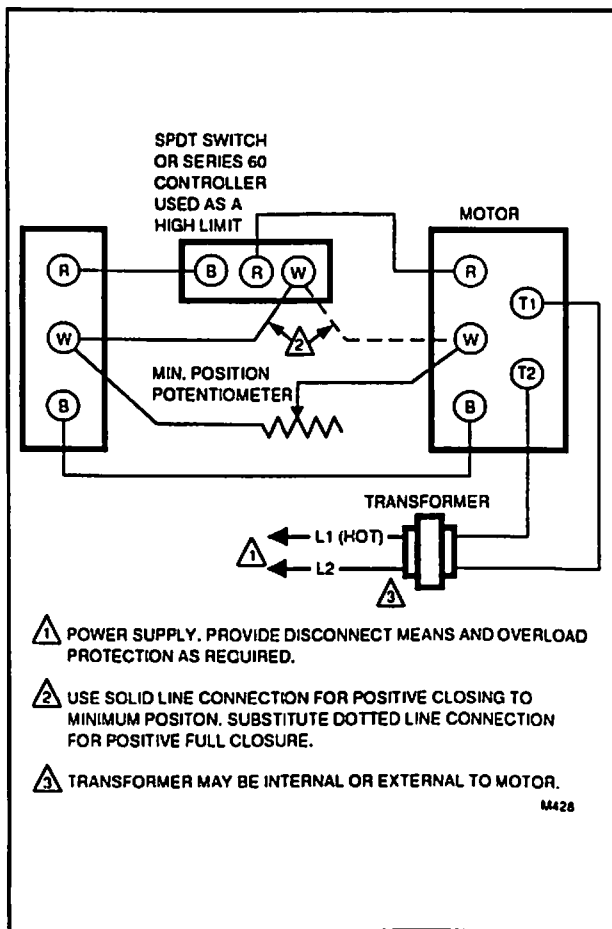

FIG. 12—CONNECTIONS FOR MOTOR, SERIES 60 CONTROLLER, MINIMUM POSITION POTENTIOMETER (ETC.).

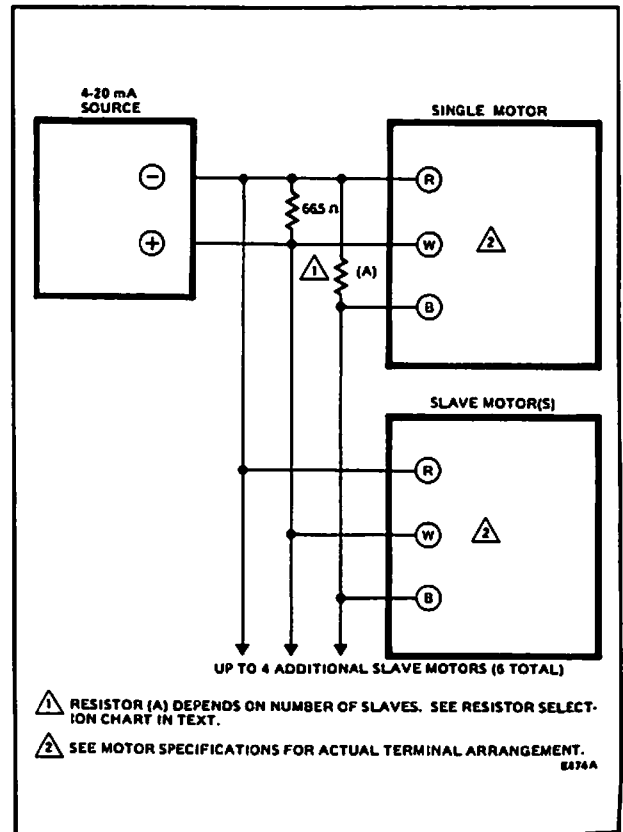

FIG. 13—CONNECTIONS FOR MOTOR USED WITH 4 TO 20 mA CONTROL.

4074EED RESISTOR SELECTION CHART FOR  
4-20 mA

MOTORS	MINIMUM OUTPUT VOLTAGE REQUIRED (Vdc) <sup>b</sup>	RESISTOR (A)	
		(Ohms)	Part No.
1	1.7	237	802139CDHA
2	2.0	150	802139BFAA
3	2.3	124	802139BCEA
4	2.7	113	802139BBDA
5	3.0	105 <sup>a</sup>	—
6	3.3	97.6 <sup>a</sup>	—

<sup>a</sup> Not part of this kit, obtain separately.

<sup>b</sup> These values represent the controller output voltage required to drive the motors.

**CHECKOUT**

After installation and linkage adjustment, check the entire motor and control hookup to ensure that—

- The motor operates the damper or valve properly.
- The motor responds properly to the controller.

Inspect the motor, linkage, and valve or damper to see that all mechanical connections are correct and secure. In damper installations, the pushrod should not extend more than a few inches past the ball joints. Check to see that there is adequate clearance for the linkage to move through its stroke without binding or striking other objects.

Check to see that cams operate the auxiliary switches, if used, at the desired point of motor rotation.

NOTE: Motors are shipped in the fully closed position (the limit of counterclockwise rotation as viewed from the power end of the motor) with the stroke set at 90°.

SERIES 90 MOTORS OPERATION CHECK WITH MODUTROL MOTOR DISCONNECTED FROM CONTROLLER

STEP	ACTION	RESPONSE	IF NO OR LIMITED RESPONSE
1.	Apply 24 Vac <sup>a</sup> .	None.	—
2.	Open terminal B and short W to R.	Motor drives closed.	Proceed to Step 6.
3.	Open terminal W and short B to R.	Motor drives open.	Proceed to Step 6.
4.	Connect terminals R to B to W.	Motor must drive to Mid-position.	Proceed to Step 6.
5.	Remove jumpers from R, B, and W. Check voltage between B and R, and W and R.	17 to 20 Vdc.	No voltage or out of range. Proceed to Step 7.
6.	Motor does not drive.	Motor is defective.	Replace motor.
7.	Voltage out of range.	Motor printed wiring board is defective.	Replace motor.
8.	Disconnect 24 Vac.	Spring return motors return to their normal mechanical position.	Spring mechanism defective —replace motor.

NOTES:

<sup>a</sup> Ensure motor transformer is sized properly. If a common transformer is used to power multiple motors, ensure power input is in phase with all motors.

<sup>b</sup> Motors may operate in Series 90 or two-position control applications. However, checking voltage between terminals R to B and R to W is necessary to confirm proper operation in electronic (W973, 4 to 20 mA etc.) applications.

**CHANGE-OUT**

**DAMPER APPLICATION**

1. Turn off power and remove wiring from the old actuator.

2. Remove crank arm from shaft of old actuator and remove the old actuator.

3. Check to see whether or not the mounting bracket is needed. If the linkage can reach the lower shaft position of the new actuator and if the crank arm has clearance for the needed rotation, then the bracket is not needed. Use 220738A Adapter Bracket or 221455A crank arm if crank arm must rotate through the bottom plane of the motor (for damper applications).

4a. If the bracket is not needed, mount the new actuator directly to the equipment and refer to the INSTALLATION, SETTINGS & ADJUSTMENTS, and CHECKOUT sections of these instructions as needed.

4b. If the bracket is needed, refer to the Adapter Bracket sections and see Fig. 3 as well as the INSTALLATION, SETTINGS & ADJUSTMENTS, and CHECKOUT sections of these instructions.

5. Use old mounting bolts to mount the new actuator.

6. Mount the damper crank arm and linkage to the shaft of the new actuator.

8. Use the CHECKOUT procedures to test the proper adjustment of the crank arm and linkage.

**VALVE APPLICATION**

When installing a M9484, M9494 motor in a valve application which has a Q100, Q601 or Q618 it will be necessary to use the 220738A Adapter Bracket provided to raise the motor shaft to the same height as that of the old motor. Ensure motor stroke is 160° to operate Honeywell V5011 two-way or V5013 three-way valves.

Honeywell Inc.  
U.S.A.: 1885 Douglas Drive N.  
Golden Valley, MN 55422-4386  
CANADA: 740 Ellesmere Road  
Scarborough, Ontario M1P 2V9

International Sales Offices in all principal cities of the world. Manufacturing in Australia, Canada, Finland, France, Germany, Japan, Mexico, Netherlands, Spain, Taiwan, United Kingdom, U.S.A.

PRINTED IN U.S.A.



QUALITY IS KEY