

Introduction



An RT pressure control contains a pressure operated single-pole changeover contact, the position of which depends on the pressure in the inlet connection and the set scale value. The RT series includes pressure controls for general applications within industrial and marine refrigeration.

The RT series also includes differential pressure controls, pressure controls for neutral zone regulation, and special pressure controls with gold-plated contact surfaces for PLC applications.

Features

- *Waterproof versions*
- *Wide regulating range*
- *Wide range of units for industrial and marine applications*
- *Suitable for alternating and direct current*
- *Interchangeable contact system*
- *Special versions for PLC applications*

Technical data

Cable connection
Pg 13.5.
Cable diameter 6 → 14 mm

Enclosure
IP 66 to IEC 529, except for versions with ext. reset which are to IP 54.

Ambient temperature
-50 to +70°C for pressure control housing.

Switches
See "Ordering, switches".

Approvals

RT 1	RT 1A	RT 1AL	RT 5	RT 5A	RT 6W, 6B, 6S	RT 6AW, 6AB, 6AS	RT 30AW, 30AB, 30AS	RT 36B, 36S	RT 117	RT 117L	RT 200	RT 200L	RT 260A	RT 262A	
•	•	•	•	•	•	•	•	•	•	•	•	•	•	•	DEMKO, Denmark
			•						•		•				Lloyd's Register of Shipping, UK
•			•		•		•		•		•				® Germanischer Lloyd, Germany
•	•	•	•	•	•	•	•	•	•	•	•	•	•	•	Nasthol, Russian Federation
									•		•				Det norske Veritas, Norway
								•							TÜV Vd TÜV, Germany
			•						•		•				Bureau Veritas, France
•	•		•	•	•				•		•				® Polski Rejestr Statków, Poland
•	•		•						•		•		•	•	RINA, Registro Italiano Navale, Italy
•	•	•		•	•	•	•	•	•	•	•	•	•	•	RMRS, Russian Maritime Register of Shipping
					•	•	•								® DIN CERTCO, Germany
•	•		•	•					•		•				NKK, Japan
			•				•		•		•				Korean Register of Shipping
•	•	•	•	•	•	•	•	•	•	•	•	•	•	•	CE mark according to 60947-4, -5

Materials in contact with the medium

Type	Material	W. no.	To DIN	Comments
RT 117, RT 117L RT 200, RT 200L	Stainless steel 18/8 Stainless steel 17/7 Brass Brass	1.4306 1.4568 2.0402 2.0321	17440 17224 1782 17660	
RT 1A, RT 1AL RT 5A, RT 5AL RT 260A, RT 262A RT 265A	Stainless steel 18/8 Plain carbon steel Deep drawing steel Plain carbon steel Case-hardened steel Aluminium	1.4306 1.0338 1.0402 1.0401 3.0255	17440 17223 1624 1652 17210 1712	Zn5Cro (RT 1A, RT 1AL only) Nickel-plated, tinned Zn5Cro Nickel-plated
RT 1, RT 5	Stainless steel 18/8 Plain carbon steel Deep drawing steel	1.4306 1.0338	17440 17223 1624	Zn5Cro (RT 1 only) Nickel-plated, tinned
RT 6W, 6B, 6S RT 6AW, 6AB, 6AS	Stainless steel 18/8 Deep drawing steel Case-hardened steel Free-cutting steel Plain carbon steel Aluminium	1.4306 1.0338 1.1141 1.0718 1.0402 3.0255	17440 1624 1652 1651 1652 1712	Nickel-plated, tinned Nickel-plated Nickel-plated Zn5Cro (RT 6AW, 6AB, 6AS) (RT 6AW, 6AB, 6AS only)
RT 30AW, 30AB, 30AS RT 36B, 36S	Stainless steel 18/8 Stainless steel 17/7 Deep drawing steel Stainless steel 18/8 STW 22 Free-cutting steel	1.4306 1.4568 1.0338 1.4305 1.0332 1.0718	17440 17224 1624 17440 1614 1651	Nickel-plated, tinned Nickel-plated Nickel-plated

Ordering

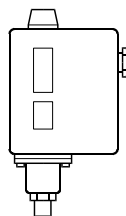

Pressure controls for fluorinated refrigerants

Pressure	Type	Regulation range bar	Differential Δp bar	Reset	Max. working pressure PB bar	Max. test pressure p' bar	Code no.	
							Connection	
							1/4 in. / 6mm flare	G 3/8 A ¹⁾
Low	RT 1	- 0.8 → 5	0.5 → 1.6	Aut.	22	25	017-5245	
		- 0.8 → 5	Fixed 0.5	Man.	22	25	017-5246	
	RT 200	0.2 → 6	0.25 → 1.2	Aut.	22	25		017-5237
High	RT 5	4 → 17	1.2 → 4	Aut.	22	25	017-5250	
		4 → 17	Fixed 1.2	Man.	22	25	017-5251	
	RT 117	10 → 30	1 → 4	Aut.	42	47		017-5295

¹⁾ BSP ext. thread, ISO 228/1.

Pressure controls for R 717 (NH₃) and fluorinated refrigerants

Pressure	Type	Regulation range bar	Differential Δp bar	Reset	Max. working pressure PB bar	Max. test pressure p' bar	Code no.	
							Connection	
							Cutting ring \varnothing 6 mm	G 3/8 A ¹⁾ + weld nipple \varnothing 6.5/10 mm
Low	RT 1A	- 0.8 → 5	0.5 → 1.6	Aut.	22	25	017-5019	017-5001
		- 0.8 → 5	Fixed 0.5	Man.	22	25	017-5027	017-5002
		- 0.8 → 5	1.3 → 2.4	Aut.	22	25		017-5007
High	RT 5A	4 → 17	1.2 → 4	Aut.	22	25	017-5052	017-5046
		4 → 17	Fixed 1.2	Man.	22	25	017-5061	017-5047

¹⁾ BSP ext. thread, ISO 228/1.

Pressure controls with DIN 32733 approvals *)

Press.	Type	Regulation range bar	Differen. Δp bar	Reset	Max. working pressure PB bar	Max. test pressure p' bar	Code no.			
							Connection			
							1/4 in./ 6 mm flare	Cutting ring \varnothing 6 mm	G 3/8 A ¹⁾ + weld nipple \varnothing 6.5/10 mm	G 1/2 A ¹⁾
High	RT 36B ²⁾	0 → 2.5	Fixed 0.2	Man.	22	25	017-5258			
	RT 36S ²⁾	0 → 2.5	Fixed 0.2	Man.	22	25	017-5259			
High	RT 6W ²⁾	5 → 25	Fixed 3	Aut.	34	38	017-5031			
	RT 6B ²⁾	10 → 28	Fixed 1	Man.	34	38	017-5034			
	RT 6S ²⁾	10 → 28	Fixed 1	Man.	34	38	017-5075			
High	RT 30AW ³⁾	1 → 10	Fixed 0.8	Aut.	22	25				017-5187
	RT 30AB ³⁾	1 → 10	Fixed 0.4	Man.	22	25				017-5188
	RT 30AS ³⁾	1 → 10	Fixed 0.4	Man.	22	25				017-5189
High	RT 6AW ³⁾	5 → 25	Fixed 3	Aut.	34	38		017-5131	017-5032	
	RT 6AB ³⁾	10 → 28	Fixed 1.5	Man.	34	38		017-5133	017-5035	
	RT 6AS ³⁾	10 → 28	Fixed 1.5	Man.	34	38		017-5146	017-5076	

*) Meets the requirements in VBG 20 on safety equipment and excess pressures.

W = Wächter (pressure control).
B = Begrenzer (pressure control with external reset).

S = Sicherheitsdruckbegrenzer (pressure control with internal reset).

A rupture in the bellows system of the unit will cause the compressor to stop.

¹⁾ BSP ext. thread, ISO 228/1.

²⁾ Pressure controls for fluorinated refrigerants.

³⁾ Pressure controls for R 717 (NH₃) and fluorinated refrigerants.

Pressure controls with adjustable dead zone for R 717(NH₃) and fluorinated refrigerants

Pressure	Type	Regulation range bar	Differential Δp bar	Dead zone NZ Δp bar	Max. working pressure PB bar	Max. test pressure p' bar	Code no.	
							Connection	
							Cutting ring \varnothing 6 mm	G 3/8 A ¹⁾ + weld nipple \varnothing 6.5 / \varnothing 10
Low	RT 1A ²⁾	- 0.8 → 5	Fixed 0.2	0.2 → 0.9	22	25	017L0016	017L0033
	RT 200 ³⁾	0.2 → 6	Fixed 0.25	0.25 → 0.7	22	25		017L0032
High	RT 5A ²⁾	4 → 17	Fixed 0.35	0.35 → 1.4	22	25	017L00017²⁾	017L0040
	RT 117 ³⁾	10 → 30	Fixed 1.0	1.5 → 3.5	42	47		017L0042²⁾

¹⁾ BSP ext thread, ISO 228/1.

²⁾ Pressure controls for (R 717 NH₃) and fluorinated refrigerantes

³⁾ Pressure controls for fluorinated refrigerants

²⁾ Without weld nipple.

Ordering

Differential pressure controls for R 717(NH₃) and fluorinated refrigerants

Type	Regulation range Δp bar	Differential Δp bar	Operating range for LP bellows bar	Max. working pressure PB bar	Max. test pressure p' bar	Code no.	
						Connection	
						Cutting ring Ø 6 mm	G 3/8 A ¹⁾ + weld nipple Ø 6.5 / Ø 10 mm
RT 260A	0.5 → 4	Fixed 0.3	-1 → 18	22	25	017D0014	017D0021
	0.5 → 4	Fixed 0.3	-1 → 18	22	25		017D0022²⁾
	0.5 → 6	Fixed 0.5	-1 → 36	42	47	017D0015	017D0023
	1.5 → 11	Fixed 0.5	-1 → 31	42	47	017D0016	017D0024
RT 262A	0.1 → 1.5	Fixed 0.1	-1 → 9	11	13	017D0013	017D0025
RT 265A ³⁾	1 → 6	Fixed 0.5	-1 → 36	42	47	017D00017	017D00072

¹⁾ BSP ext thread, ISO 228/1.

²⁾ Man. reset.

³⁾ Filter monitor: Alarm Δp = 0.8 bar, cut-out Δp = 1 bar (factory setting).

Differential pressure controls with adjustable dead zone for R 717(NH₃) and fluorinated refrigerants

Type	Regulation range Δp bar	Differential Δp bar	Dead zone NZ bar	Operating range for LP bellows bar	Max. working pressure PB bar	Max. test pressure p' bar	Code no.
							Connection
							G 1/2 A ¹⁾ + weld nipple Ø 6.5/10 mm
RT 262AL	0.1 → 1.5	Fixed 0.1	0.1 → 0.33	-1 → 9	11	13	017D0043²⁾

¹⁾BSP ext thread, ISO 228/1.

²⁾Differential pressure control for R 717 (NH₃) and fluorinated refrigerants.

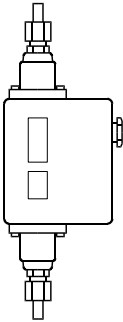









Ordering
(continued)

Special versions
RT can be supplied with special switches as follows.

When ordering, please state
1. Type
2. Code no. of standard unit
3. Code no. of special switch

Switches ¹⁾

Version	Symbol	Description	Contact rating	Code no.
Standard	 SPDT	Single-pole changeover switch with terminal board proof against leakage current. Fitted in all standard versions of type RT. Snap action changeover contacts.	Alternating current ²⁾ <i>Ohmic:</i> AC1 = 10 A, 400 V	017-4030
		Fitted in DIN pressure controls.	<i>Inductive:</i> AC3 = 4 A, 400 V AC15 = 3 A, 400 V	017-4230
With Man. reset	 SPDT	For manual reset of unit after contact changeover on rising pressure. For HP units prepared for reset facility.	<i>Dir. current</i> DC13 = 12 W, 220 V	017-4042 with Man. reset
With Man. reset	 SPDT	For manual reset of unit after contact changeover on falling pressure. For LP units prepared for reset facility.		017-4041 with Man. reset
With dead zone	 SPDT	Single-pole changeover switch with dead zone and terminal board proof against leakage current.		Available only as a component part of RT controls with adjustable dead zone
Standard	 SPDT	Single-pole changeover switch with gold plated (oxide-free) contact surfaces. Increases cut-in reliability on alarm and monitoring systems, etc. Snap action changeover contacts. Terminal board proof against leakage current.	Alternating current ²⁾ <i>Ohmic:</i> AC1 = 10 A, 400 V	017-4240
		Single-pole changeover switch with dead zone and gold plated (oxide-free) contact surfaces. Increases cut-in reliability on alarm and monitoring systems, etc. Snap action changeover contacts. Terminal board proof against leakage current.	<i>Inductive:</i> AC3 = 2 A, 400 V AC15 = 1 A, 400 V	Available only as a component part of RT controls with adjustable dead zone
With dead zone	 SPDT	Single-pole changeover switch with dead zone and gold plated (oxide-free) contact surfaces. Increases cut-in reliability on alarm and monitoring systems, etc. Snap action changeover contacts. Terminal board proof against leakage current.	<i>Dir. current</i> DC13 = 12 W, 220 V	Available only as a component part of RT controls with adjustable dead zone
Cuts in two circuits simultaneously	 SPST	Single-pole changeover switch that cuts in two circuits simultaneously on rising pressure. Snap action changeover contacts. Terminal board proof against leakage current.	Alternating current ²⁾ <i>Ohmic:</i> AC1 = 10 A, 400 V	017-4034
Cuts out two circuits simultaneously	 SPST	Single-pole changeover switch that cuts out two circuits simultaneously on rising pressure. Snap action changeover contacts. Terminal board proof against leakage current.	<i>Inductive:</i> AC3 = 3 A, 400 V AC15 = 2 A, 400 V	017-4036
With non-snap action changeover contacts	 SPDT	Single-pole changeover switch with non-snap action changeover contacts.	<i>Dir. current</i> DC13 = 12 W, 220 V ³⁾	017-0181
			<i>Alternating or direct current</i> 25 VA, 24 V	

¹⁾ RT pressure controls meet the conditions of EN 60947-2-9.

²⁾ Max. starting current (L.R.) = 7 × AC 3.

³⁾ If current is led through the contacts 2 and 4, i.e. terminals 2 and 4 connected but not terminal 1, the max. permissible load is increased by 90 W, 220V.

The switches are shown in the position they assume on falling pressure, i.e. after downward movement of the RT main spindle.

The setting pointer of the control shows the scale value at which contact changeover occurs on falling pressure.

An exception is RT with switch code no. **017-4042** with Man. reset, where the setting pointer shows the scale value at which contact changeover occurs on rising pressure.

Design
Function

Pressure control type RT

- 5. Setting knob
- 9. Regulation range scale
- 10. Loop terminal
- 11. Pg 13.5 screwed cable entry
- 12. Main spring
- 14. Terminals
- 15. Main spindle
- 16. Switch
- 17. Guide bush
- 18. Contact arm
- 19. Differential setting nut
- 23. Bellows element
- 25. Fixing hole
- 27. Connection
- 38. Earth terminal
- 39. Blow-out disc
- 44. Pressure setting spindle

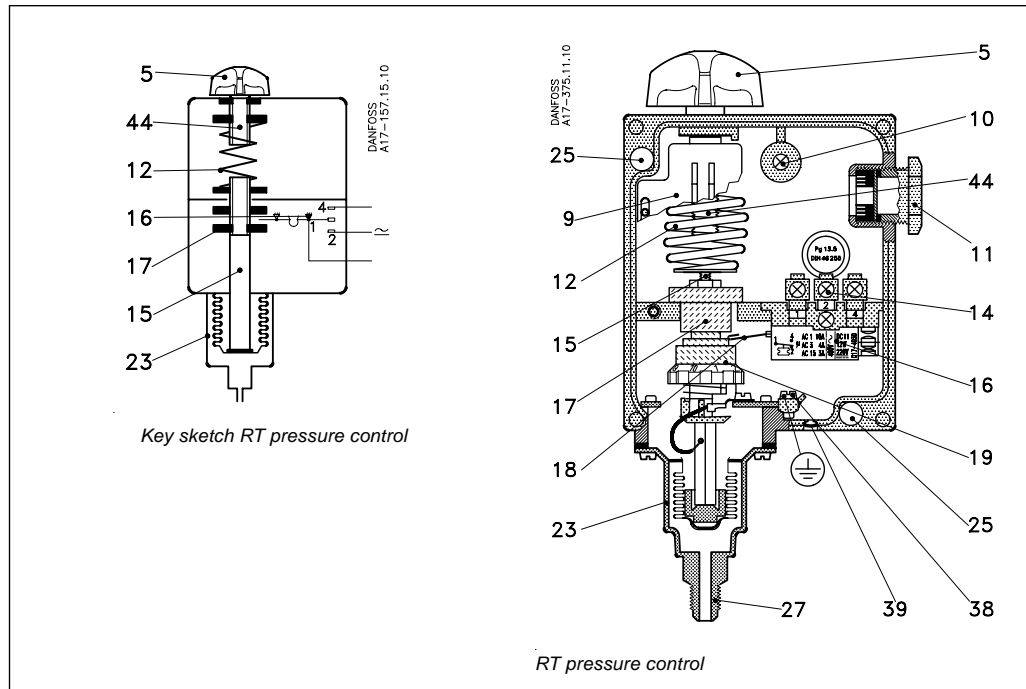

The bellows in the RT pressure control is connected to the low or high pressure side of the controlled system via the connection. By turning the setting knob (5) the main spring (12) can be set to balance the pressure in the bellows.

A rise in pressure compresses the bellows and moves the main spindle (15) upwards until spring and bellows pressure are in equilibrium. The main spindle (15) is fitted with a guide bush (17) and a differential pressure setting nut (19) that together transfer the main spindle movement to the switch (16).

The RT 6W, 6B, 6S, RT 6AW, 6AB, 6AS, RT 30AW, 30AB, 30AS, RT 36B, 36S are equipped with a double bellows (an outer bellows and a regulating bellows).

These units have been tested and approved by TÜV (Technischer Überwachungs Verein, Germany) according to DIN 32733.

- W = Wächter (pressure controls)
- B = Begrenzer (pressure controls with external reset)
- S = Sicherheitsdruckbegrenzer (pressure controls with internal reset).

General for DIN 32733 approved units

1. The units are equipped with a double bellows system. When pressure in the plant exceeds the set value, the unit will automatically stop the plant. The double bellows system prevents loss of system charge in the event of bellows rupture.
2. Versions with designation W or AW cut in again automatically when the pressure has fallen to the set value minus the differential.
3. Versions with designation B or AB are cut in manually with the external reset button. This is possible when the pressure has fallen by a value corresponding to the differential under the set value.
4. Versions with designation S or AS can be cut in manually with the internal reset arm when the pressure has fallen 4 bar under the set value.

As laid down by DIN 32733 requirements, if a rupture occurs in the regulating bellows of the unit the refrigerating system compressor will be stopped and can only be restarted when the pressure control has been replaced.

A rupture in the outer bellows will cause the cut-out pressure of RT 36 to fall 2.5 bar, and the cut-out pressure of RT 6 and RT 30 to fall 4.5 bar under the set value.

This means that the unit cuts out at normal condensing pressure and thus provides a fail-safe function.

All RT pressure controls, including those which are DIN 32733 approved, operate independently of changes in the ambient temperature around the control housing. Therefore the set cut-out pressure and differential are held constant provided the permissible ambient temperatures are not exceeded.

Design Function (continued)

Pressure control with dead zone, type RT L

- 5. Setting knob
- 9. Regulation range scale
- 11. Pg 13.5 screwed cable entry
- 12. Main spring
- 15. Main spindle
- 16. Switch
- 17. Upper guide bush
- 18. 18a, 18b. Contact arm
- 20. Lower guide bush
- 23. Bellows element
- 25. Fixing hole
- 27. Connection
- 38. Earth terminal
- 39. Blow-out disc
- 40. Neutral zone setting nut
- 44. Pressure setting spindle

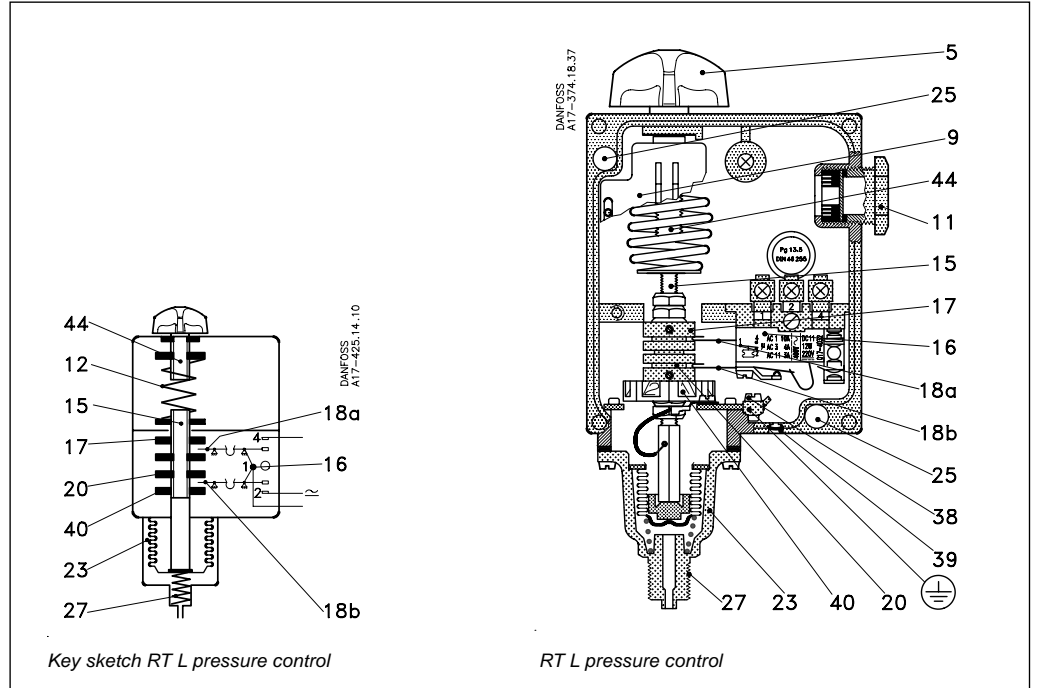

RT L pressure controls are fitted with a switch (17-4032) with an adjustable neutral zone. This enables the units to be used for floating control. The neutral zone switch contact arms (18a) and (18b) are operated by the spindle guide bushes (17) and (20).

The upper guide bush (17) is Fixed while the lower guide bush (20) can be moved up or down by the setting nut (40). In this way the neutral zone can be varied between a minimum value (equal to the mechanical differential of the unit) and a maximum value (depending on the type of RT unit).

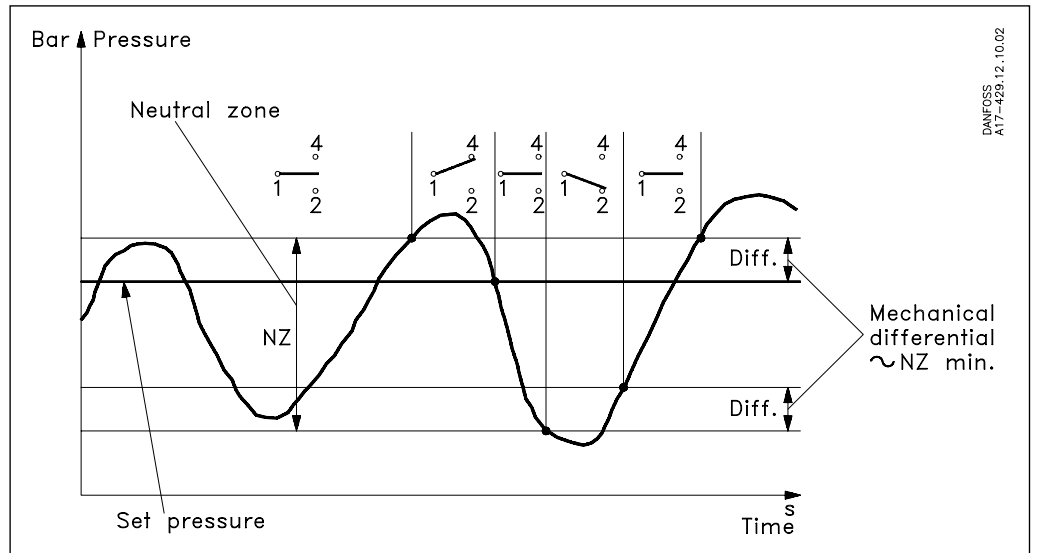

Design Function
(continued)

Differential pressure control, type RT

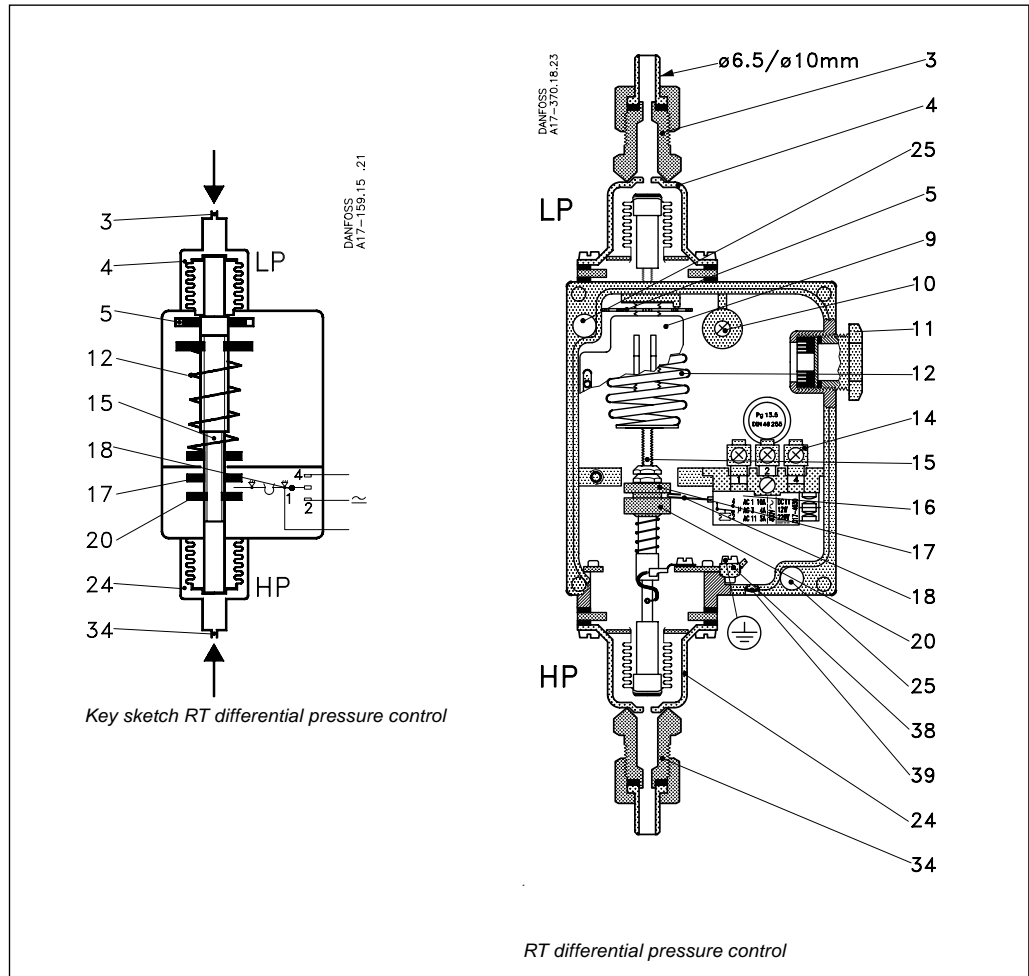

- 3. LP connection
- 4. LP bellows element
- 5. Setting disc
- 9. Regulation range scale
- 10. Coil clamp
- 11. Pg 13.5 screwed cable entry
- 12. Main spring
- 14. Terminals
- 15. Main spindle
- 16. Switch
- 17. Upper guide bush
- 18. Contact arm
- 20. Lower guide bush
- 24. HP bellows element
- 25. Fixing hole
- 34. HP connection
- 38. Earth terminal
- 39. Blow-out disc

An RT differential pressure control contains a single-pole changeover switch that makes or breaks depending on the pressure differential between two counteracting bellows elements (LP and HP).

Differential pressure controls are used primarily as protection against too low a differential pressure across liquid circulation pumps. A secondary application is the safeguarding of lubricating oil pressure in refrigeration compressors.

The function of the pressure control is conditional only on the differential pressure, i.e. the difference in pressure between the two counteracting bellows, whereas it is independent of the absolute pressure on both bellows. The bellows (4) and (24) are respectively connected to the LP port (lowest pressure) and the HP port (highest pressure). The main spring (12) can be set for different differential pressures by the setting disc (5).

If the differential pressure between highest and lowest pressures falls, the spindle (15) moves downwards and via the upper guide bush (17) actuates the switch contact arm (18). The reverse function occurs if the differential pressure rises.

For RT 260A controls used on screw compressors the following applies ¹⁾

1. Max. pressure in low pressure bellows ~ condensing pressure = 21 bar.
2. Max. pressure in high pressure bellows ~ lubricating oil pressure = 24 bar.
3. Differential between condensing pressure and lubricating oil pressure must not exceed 3 bar.
4. Pressure change in the low and high pressure bellows from start to normal operation must not exceed 8 bar.

¹⁾ Since the operating conditions given, are outside the operating range of the unit, the life of the bellows will be reduced to approx. 10 000 operations as against approx. the normal 400 000.

Terminology

Floating control

A form of delayed control where the correcting element (e.g. valve, damper, or similar) moves towards one extreme position at a rate independent of the magnitude of the error when the error exceeds a definite positive value, and towards the opposite extreme position when the error exceeds a definite negative value.

Hunting

Periodic variations of the controlled variable from the Fixed reference.

Neutral zone

The interval between the make points of the two contacts.

"Snap function"

A certain contact force is maintained until irrevocable "snap" is initiated. The time during which the contact force approaches zero is thus limited to a very few milliseconds. Therefore contact bounce cannot occur as a result of, for example, slight vibrations, before the cut-out point. Contact systems with "Snap function" will change over even when micro-welds are created between the contacts during cut-in. A very high force is created during cut-out to separate the contacts. This force immediately shears off all the welds. Thus the cut-out point of the unit remains very accurate and completely independent of the magnitude of the current load.

Setting

RT with automatic reset - LP

The knob is used to set the lowest pressure at which the contact system must be activated (cut-out or cut-in). This value can be read on the main scale of the unit. The differential roller must be used to set the differential. Highest activating pressure = lowest activating pressure + set differential.

RT with manual reset - LP

RT pressure controls RT 1 and RT 1A are obtainable in versions with min. reset. When the pressure falls to the setting value the pressure control cuts out. Manual reset becomes possible when the pressure in the bellows system has risen to a value corresponding to the set value + the differential. On falling pressure the follower activates the contact system arm and the contact changes over. The scale is calibrated so that the scale value corresponds to contact changeover on falling pressure.

RT with automatic reset - HP

The knob can be used to set the lowest pressure at which the contact system must be activated (cut-out or cut-in). This value can be read on the main scale of the unit. The differential must be set with the differential roller. Highest activating pressure = lowest activating pressure + set differential.

RT with manual reset - HP

RT pressure controls RT 5 and RT 5A are obtainable in versions with max. reset. When the pressure has risen to the set value the pressure control cuts out. Manual reset only becomes possible when the pressure has fallen to a value corresponding to the set pressure minus the differential. The differential roller is then used as a follower. On rising pressure the differential roller activates the contact system arm and the contact changes over. The scale is calibrated so that the scale values correspond to contact changeover on rising pressure, which is opposite to RT units with automatic reset.

Dimensions and weight

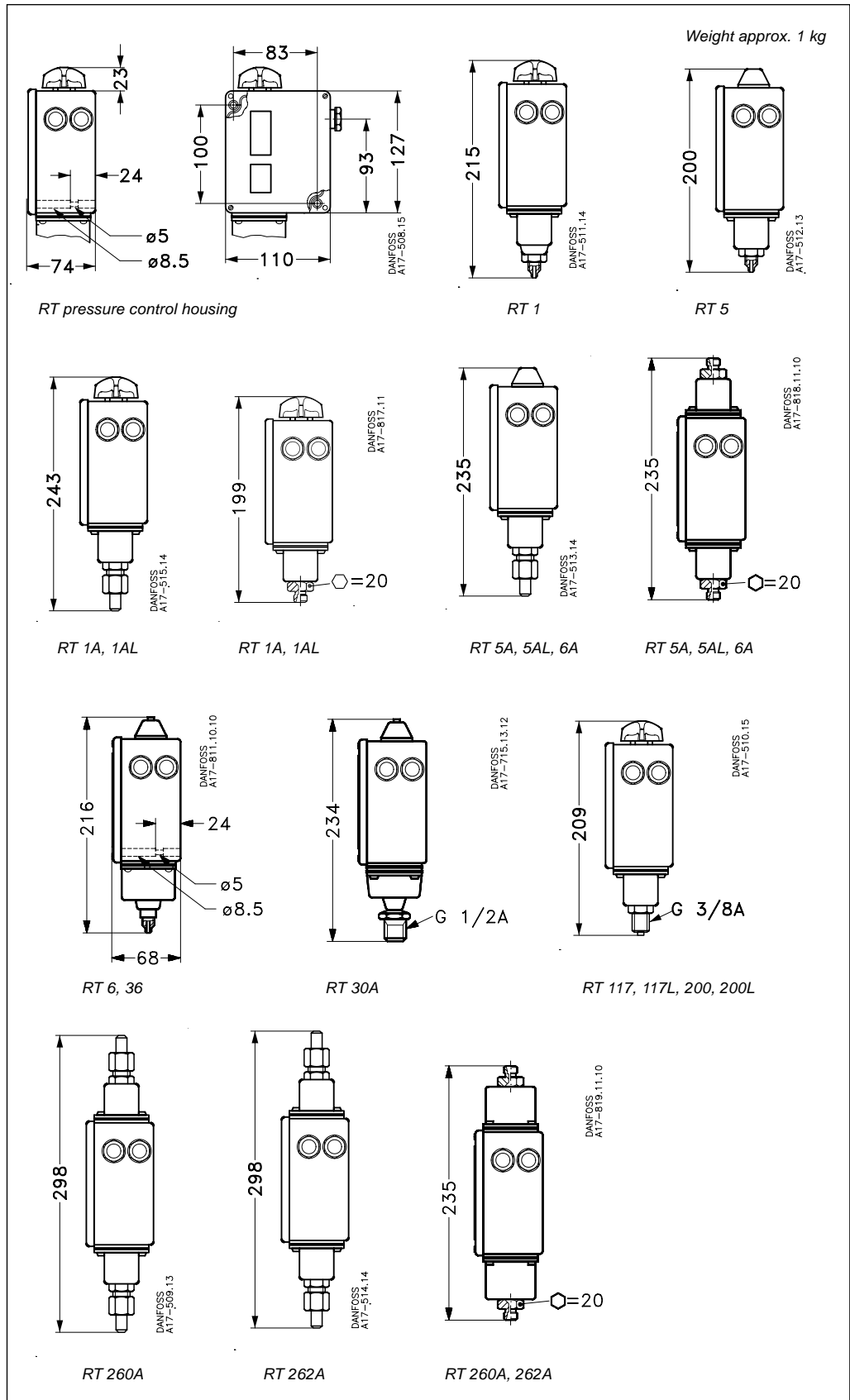

Danfoss can accept no responsibility for possible errors in catalogues, brochures and other printed material. Danfoss reserves the right to alter its products without notice. This also applies to products already on order provided that such alterations can be made without subsequential changes being necessary in specifications already agreed. All trademarks in this material are property of the respective companies. Danfoss and the Danfoss logotype are trademarks of Danfoss A/S. All rights reserved.



DK-6430 Nordborg
Denmark