

Kombi Valves

V5032 Kombi-2-plus

BALANCING AND SHUTOFF VALVE

PRODUCT DATA

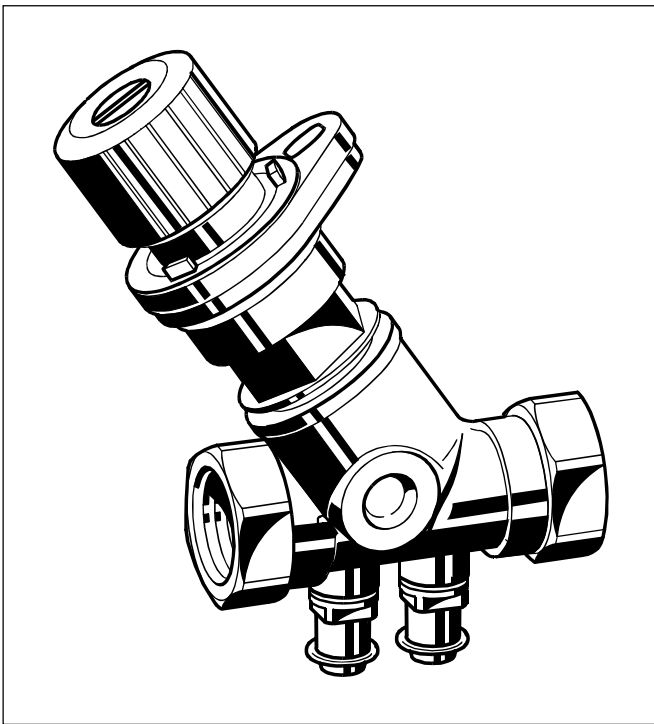

Design

The Kombi-2-plus valve consists of:

- Valve body with pressure test cocks and internal threads DN10...DN20 to DIN2999 (ISO7) for threaded pipe or copper and precision steel pipe 10...20 mm (see Accessories), or
- Valve body DN25...DN80 with pressure test cocks and internal threads to DIN2999 (ISO7) for threaded pipe
- Valve insert
- Blue handwheel with pre-setting dial and display

Materials

- Valve housing made of red bronze
- Valve insert and pressure test cocks made of brass
- O-rings and soft seals made of EPDM
- Handwheel, pre-setting dial and display made of plastic

CONTENTS

Design	1
Materials	1
Application	1
Features	1
Specifications	2
Function	2
Dimensions, kvs-values and Ordering Information	2
Accessories	3
Connections	3
Accessories	3
Measuring equipment.....	3
Spare parts.....	3
Flow Data	4 to 11
Influence of Coolants on Flow Values	12
Correction Factor f	12

Application

The Kombi-2-plus is installed in the return mains of pump driven warm water heating systems and cold water cooling systems to regulate the hydronic balance and as shutoff valve. The Kombi-2-plus has an O-ring spindle seal and is maintenance free. The valve body can be insulated easily and is equipped with pressure test cocks for differential pressure or flow measurement.

Further functions can be retrofitted without interrupting operation of the system: draining, filling and automatic regulation (in combination with a Kombi-3-plus BLACK valve in the supply and a Kombi-Diaphragm Unit).

Features

- **Maintenance free spindle with double O-ring sealings**
- **PTFE seat sealing**
- **High accuracy of the pre-setting because of individual adjustment**
- **Valve body PN16**
- **Dimensions DN15 to DN40 can be retrofitted with a Kombi-Diaphragm Unit**
- **Robust valve body made of corrosion resistant red bronze**
- **Available in sizes up to DN80**
- **Visible pre-setting dial with concealed pre-setting wheel**

Specifications

Medium	Water, water-glycole mixture
Operating temperature	2...130°C (36...266°F)
Operating pressure	max. 16 bar (232 psi)
Differential pressure	max. 2,0 bar (29 psi) – see NOTE below
k_{vs} (cv)-values	see table on page 2

NOTE: Differential pressure: Closing pressure for Kombi-2-plus with installed Kombi-Diaphragm Unit. Regarding noise generation the conditions, requirements and installation design have to be taken into account.

Function

The hydronic balance is a significant requirement for the efficient operation of a hydronic heating or cooling installation. In an unbalanced system under or over provision of hot water to individual radiators or circuits can occur. Apart from the correct selection of radiator valves, regulation of individual circuits is also necessary and in some cases, such as in DIN 18 380, VOB part C, is required by national standards.

This requirement is met with the shutoff and balancing valve Kombi-2-plus. The Kombi-2-plus for the return has the functions shutoff, pre-setting, regulation (with diaphragm unit, accessory), draining and filling (draining adapter, accessory).

Dimensions, k_{vs}-values and Ordering Information

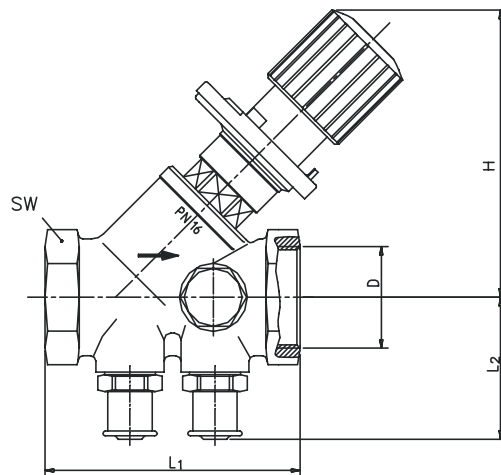

Type	DN	k _{vs} (cv)-value	Dimensions					OS-No.
			D	H	L ₁	L ₂	SW	
Internal threads	15	2,7 (3,16)	Rp1/2"	85	65	41	27	V5032Y0015
Internal threads	20	6,4 (7,49)	Rp3/4"	100	75	42	32	V5032Y0015
Internal threads	25	6,8 (7,96)	Rp1"	100	90	45	41	V5032Y0015
Internal threads	32	21,0 (24,6)	Rp1 1/4"	137	110	46	50	V5032Y0015
Internal threads	40	22,0 (25,7)	Rp1 1/2"	137	120	49	55	V5032Y0015
Internal threads	50	38,0 (44,5)	Rp2"	158	150	55	70	V5032Y0015
Internal threads	65	47,7 (55,8)	Rp2 1/2"	195	180	68	85	V5032Y0015
Internal threads	80	71,0 (83,1)	Rp3"	210	200	75	100	V5032Y0015

NOTE: All values in mm if not stated otherwise.
Dimension 'H' refers to fully open valve.

Accessories

Connections

Set of compression ring and nut

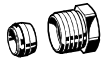
	1/2" x 10 mm	VA650A1210
	1/2" x 12 mm	VA650A1212
	1/2" x 14 mm	VA650A1214
	1/2" x 15 mm	VA650A1215
	1/2" x 16 mm	VA650A1216
	3/4" x 18 mm	VA650A2018
	3/4" x 22 mm	VA650A2022

NOTE: Support inserts have to be used for soft copper and steel pipe (wall thickness 1 mm).

Set of compression ring, nut and support insert (2 pcs each)

	1/2" x 12 mm	VA651A1212
	1/2" x 15 mm	VA651A1215
	1/2" x 16 mm	VA651A1216
	3/4" x 18 mm	VA651A2018

Accessories

Kombi-DU Diaphragm Unit (V5012) for valves DN15...DN40

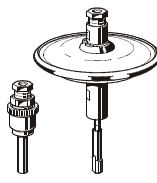
	Setting range 0,1...0,3 bar (1,45...4,35 psi) differential pressure	V5012A0103
	Setting range 0,3...0,6 bar (4,35...8,7 psi) differential pressure	V5012A0306

NOTE: For product information and diagrams see product data sheet 'V5012 Kombi-DU'.

The Kombi-2-plus valve must be pre-set to 1.5 (for DN15...25) or 1.0 (DN32...40) when used with the Kombi-Diaphragm Unit.

Pump pressure: max. 2 bar (29 psi)

Kombi-3-plus BLACK (V5100) as shutoff valve and Kombi-DU connection point in the supply

	DN15	V5100Y0015
	DN20	V5100Y0020
	DN25	V5100Y0025
	DN32	V5100Y0032
	DN40	V5100Y0040

Tamper-proof cap

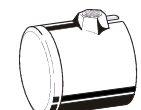
	for valves DN15...DN25	VA2501A010
	for valves DN32...DN50	VA2501A032

Adapter for actuators with M 30 x 1,5 connection

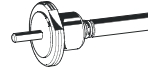
	for valves DN15...DN40	VA2500A001
---	------------------------	------------

Kvs-values for Kombi-2-plus with installed adapter:

DN	15	20	25	32	40
kvs-value	1,50	3,50	3,50	5,50	5,50
cv-value	1,76	4,1	4,1	6,44	6,44

NOTE: The Kombi-2-plus valve must be pre-set to 1.5 (for DN15...25) or 1.0 (DN32...40) when used with actuator.

Pump pressure: max. 2 bar (29 psi)

Draining adapter

	for all sizes	VA3500A001
---	---------------	------------

Measuring equipment

Extension piece for pressure test cocks, length 45 mm – for use with insulated Kombi-2-plus

	for all sizes	VA2601A008
--	---------------	------------

Measuring adapters (2 pcs)

	for all sizes	VS3600A008
---	---------------	------------

Flow meter

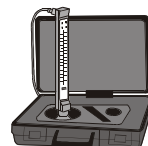
	for all sizes	VM200A1001
---	---------------	------------

'BasicMES' handheld measuring computer

	for all sizes; computer is supplied with case and accessories	VM241A1002
---	---	------------

Spare parts

Pressure test cocks (2 pcs)

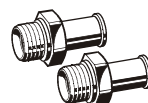
	for all sizes	VA2600A008
---	---------------	------------

Flow Data DN15

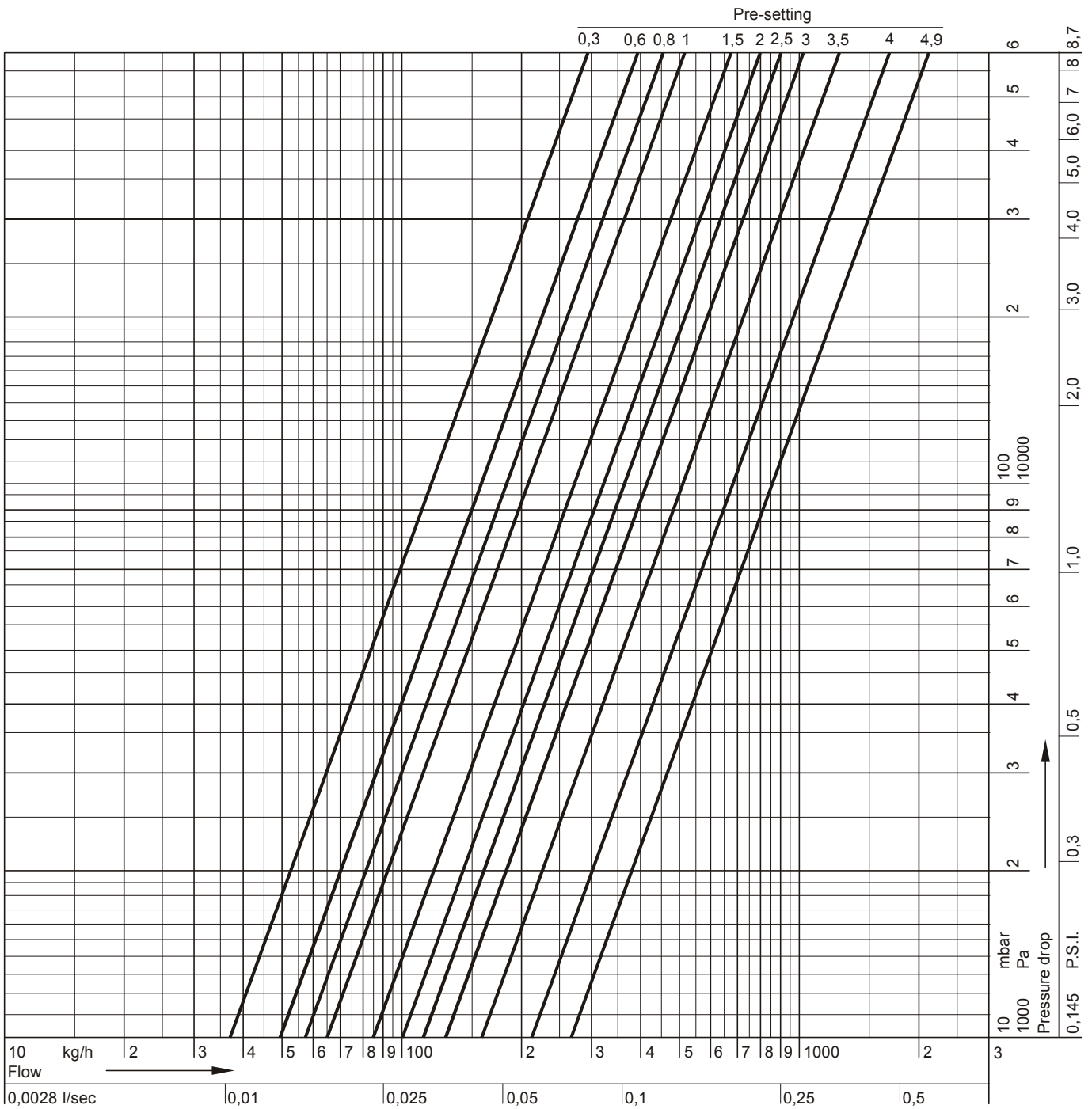

Pre-setting	0,3	0,4	0,6	0,8	1,0	1,2	1,4	1,6	1,8	2,0	2,2	2,4	2,6	2,8	3,0	3,2	3,4	3,6
k_v-value	0,37	0,43	0,49	0,57	0,65	0,73	0,81	0,88	0,94	1,00	1,05	1,10	1,16	1,22	1,32	1,42	1,57	1,74
cv-value	0,43	0,50	0,57	0,67	0,76	0,85	0,95	1,03	1,10	1,17	1,23	1,29	1,36	1,43	1,54	1,66	1,84	2,04

Pre-setting	3,8	4,0	4,2	4,4	4,6	4,8	4,9 = open
k_v-value	1,92	2,12	2,31	2,49	2,63	2,67	k _{vs} = 2,70
cv-value	2,25	2,48	2,70	2,91	3,08	3,12	3,16

NOTE: Flow diagram is ONLY valid for valve WITHOUT installed actuator (-adapter) or Kombi-Diaphragm Unit

Flow Data DN20

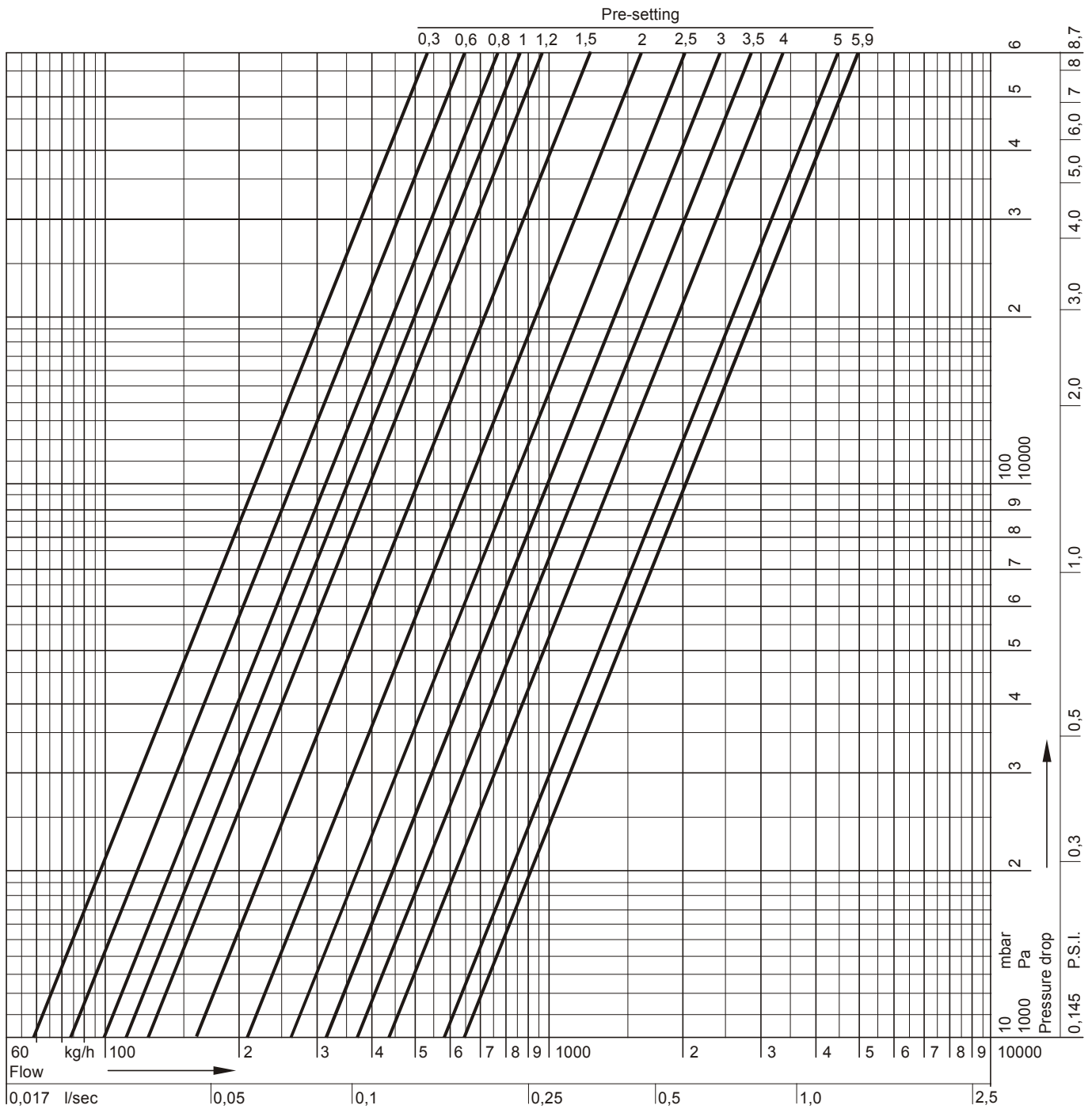

Pre-setting	0,3	0,4	0,6	0,8	1,0	1,2	1,4	1,6	1,8	2,0	2,2	2,4	2,6	2,8	3,0	3,2	3,4	3,6
k_v-value	0,68	0,72	0,84	0,97	1,10	1,30	1,50	1,70	1,90	2,10	2,30	2,50	2,70	2,91	3,12	3,36	3,60	3,86
cv-value	0,80	0,84	0,98	1,13	1,29	1,52	1,76	1,99	2,22	2,46	2,69	2,93	3,16	3,40	3,65	3,93	4,21	4,52

Pre-setting	3,8	4,0	4,2	4,4	4,6	4,8	5,0	5,2	5,4	5,6	5,8	5,9 = open
k_v-value	4,12	4,40	4,69	4,99	5,28	5,57	5,84	6,07	6,26	6,32	6,38	k _{vs} = 6,40
cv-value	4,82	5,15	5,49	5,84	6,18	6,52	6,83	7,10	7,32	7,39	7,46	7,49

NOTE: Flow diagram is ONLY valid for valve WITHOUT installed actuator (-adapter) or Kombi-Diaphragm Unit

Flow Data DN25

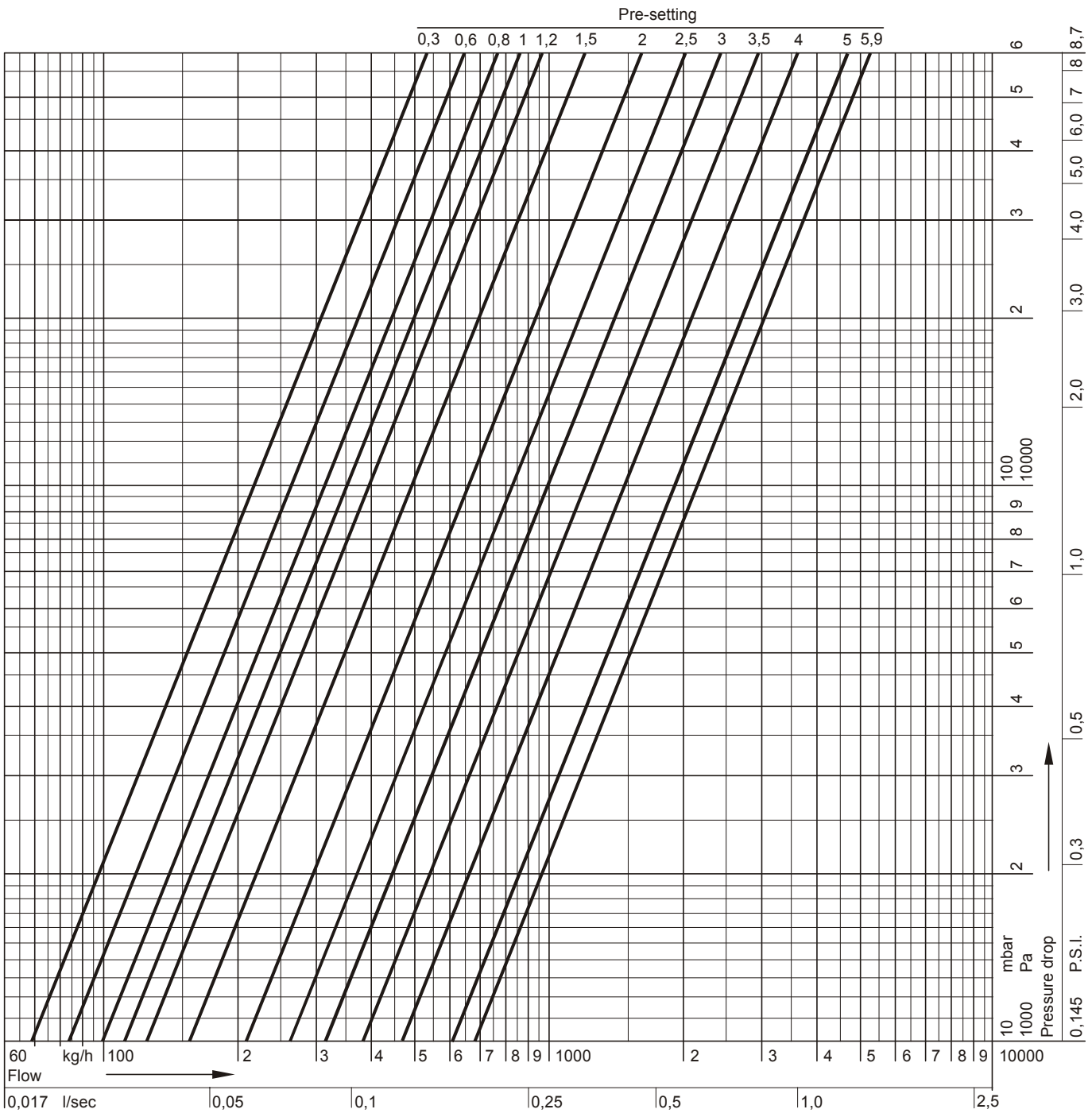

Pre-setting	0,3	0,4	0,6	0,8	1,0	1,2	1,4	1,6	1,8	2,0	2,2	2,4	2,6	2,8	3,0	3,2	3,4	3,6
k_v-value	0,68	0,72	0,84	0,97	1,10	1,30	1,50	1,70	1,90	2,10	2,30	2,50	2,70	2,95	3,20	3,48	3,76	4,05
cv-value	0,80	0,84	0,98	1,13	1,29	1,52	1,76	1,99	2,22	2,46	2,69	2,93	3,16	3,45	3,74	4,07	4,40	4,74

Pre-setting	3,8	4,0	4,2	4,4	4,6	4,8	5,0	5,2	5,4	5,6	5,8	5,9 = open
k_v-value	4,34	4,64	4,94	5,24	5,52	5,80	6,06	6,30	6,50	6,65	6,75	k _{vs} = 6,80
cv-value	5,08	5,43	5,78	6,13	6,46	6,79	7,09	7,37	7,61	7,78	7,90	7,96

NOTE: Flow diagram is ONLY valid for valve WITHOUT installed actuator (-adapter) or Kombi-Diaphragm Unit

Flow Data DN32

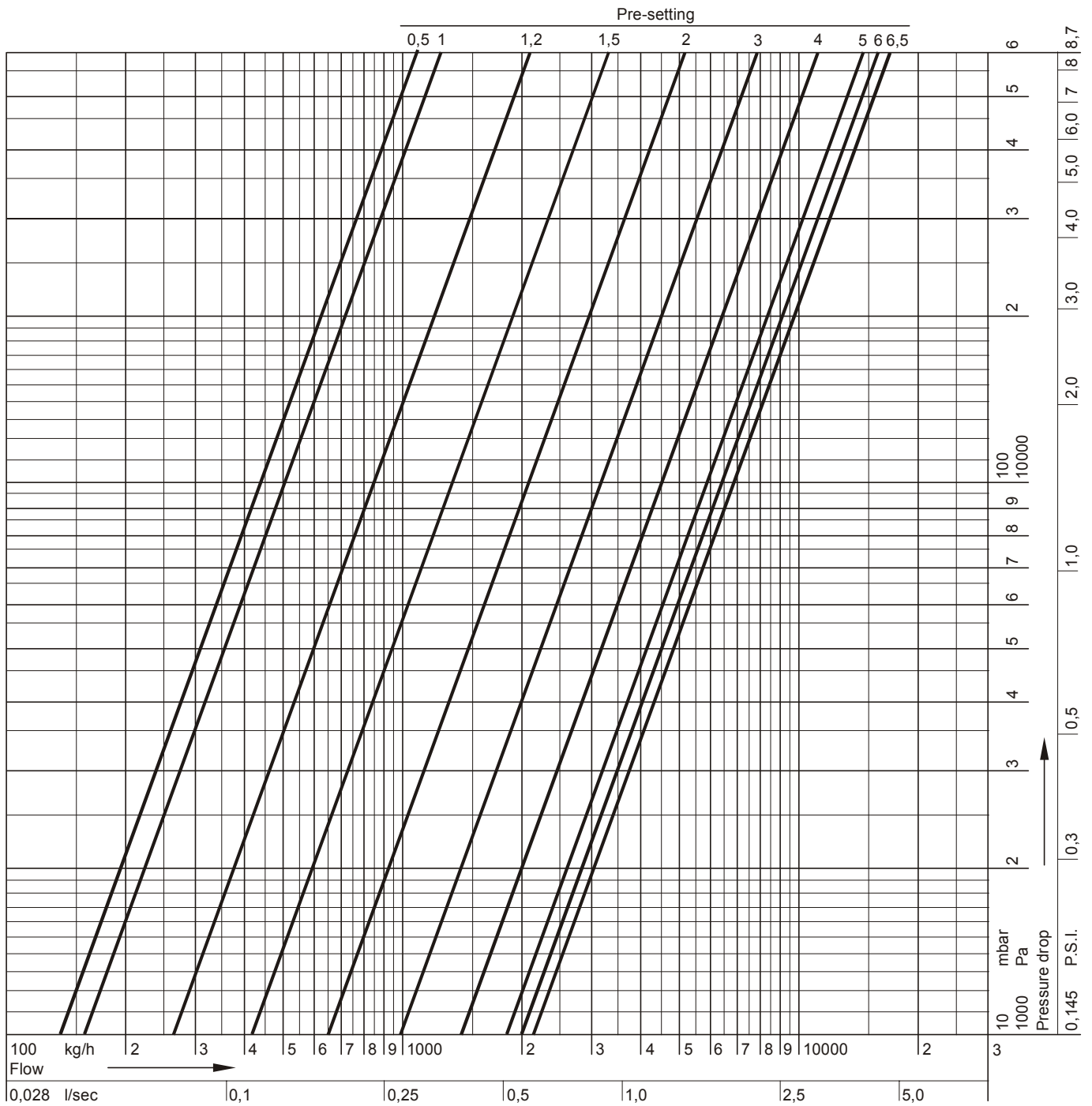

Pre-setting	0,5	0,6	0,8	1,0	1,2	1,4	1,6	1,8	2,0	2,2	2,4	2,6	2,8	3,0	3,2	3,4	3,6	3,8
k_v-value	1,40	1,45	1,55	1,60	2,60	3,70	4,80	5,90	6,50	6,90	7,50	8,30	9,20	10,2	11,2	12,2	13,2	14,1
cv-value	1,64	1,70	1,81	1,87	3,04	4,33	5,62	6,90	7,61	8,07	8,78	9,71	10,8	11,9	13,1	14,3	15,4	16,5

Pre-setting	4,0	4,2	4,4	4,6	4,8	5,0	5,2	5,4	5,6	5,8	6,0	6,2	6,4	6,5 = open
k_v-value	15,0	15,8	16,5	17,1	17,7	18,2	18,6	19,0	19,4	19,7	20,0	20,4	20,8	k _{vs} = 21,0
cv-value	17,6	18,5	19,3	20,0	20,7	21,3	21,8	22,2	22,7	23,0	23,4	23,9	24,3	24,6

NOTE: Flow diagram is ONLY valid for valve WITHOUT installed actuator (-adapter) or Kombi-Diaphragm Unit

Flow Data DN40

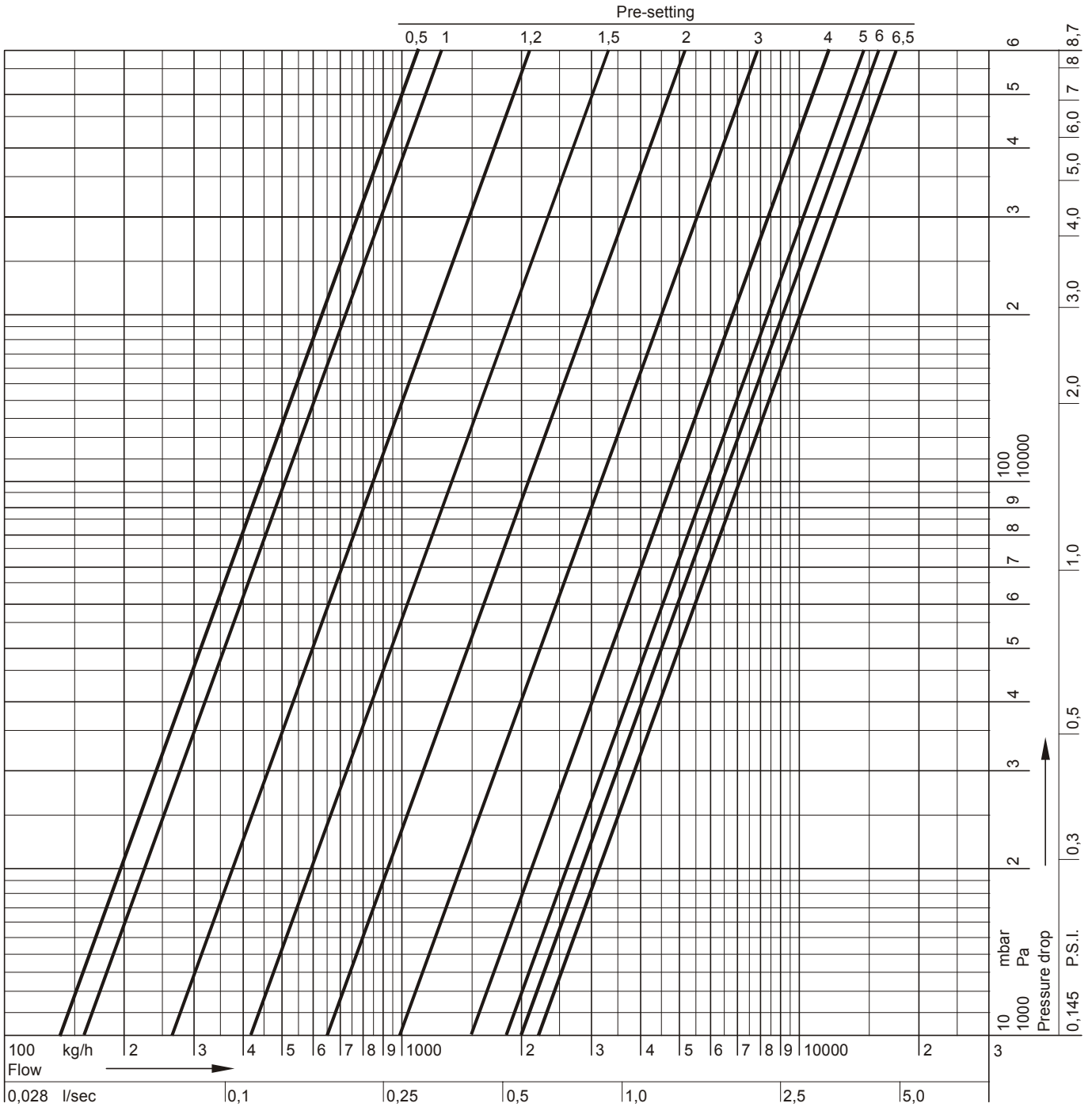

Pre-setting	0,5	0,6	0,8	1,0	1,2	1,4	1,6	1,8	2,0	2,2	2,4	2,6	2,8	3,0	3,2	3,4	3,6	3,8
k_v-value	1,40	1,45	1,55	1,60	2,60	3,70	4,80	5,90	6,50	6,90	7,50	8,30	9,20	10,2	11,2	12,2	13,2	14,1
cv-value	1,64	1,70	1,81	1,87	3,04	4,33	5,62	6,90	7,61	8,07	8,78	9,71	10,8	11,9	13,1	14,3	15,4	16,5

Pre-setting	4,0	4,2	4,4	4,6	4,8	5,0	5,2	5,4	5,6	5,8	6,0	6,2	6,4	6,5 = open
k_v-value	15,0	15,8	16,5	17,1	17,7	18,2	18,6	19,0	19,4	19,7	20,0	20,8	21,6	k _{vs} = 22,0
cv-value	17,6	18,5	19,3	20,0	20,7	21,3	21,8	22,2	22,7	23,0	23,4	24,3	25,3	25,7

NOTE: Flow diagram is ONLY valid for valve WITHOUT installed actuator (-adapter) or Kombi-Diaphragm Unit

Flow Data DN50

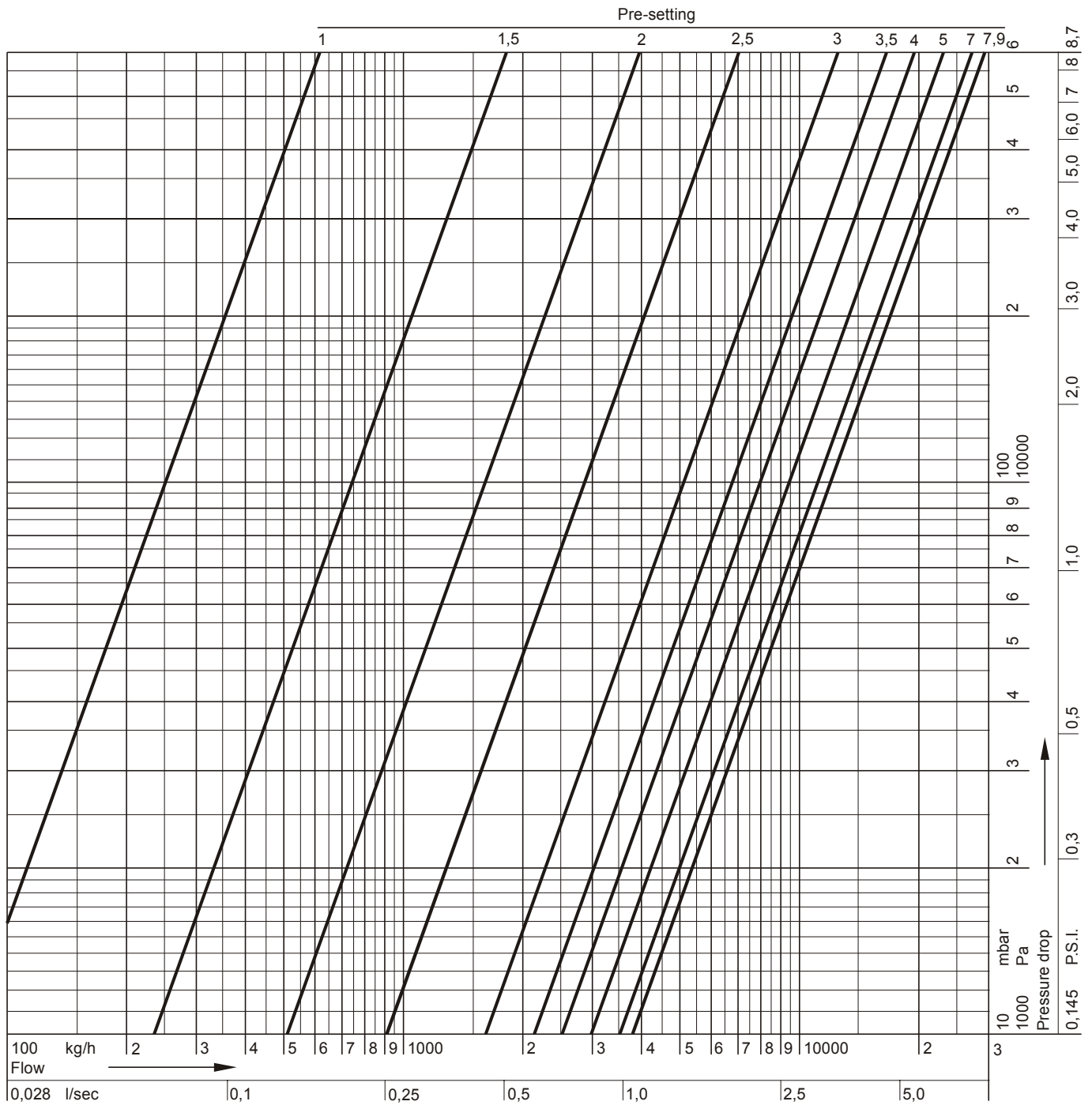

Pre-setting	1,0	1,2	1,4	1,6	1,8	2,0	2,2	2,4	2,6	2,8	3,0	3,2	3,4	3,6	3,8	4,0	4,2	4,4
k_v-value	0,80	1,25	1,88	2,72	3,78	5,10	6,68	8,54	10,7	13,0	15,6	18,7	21,0	22,8	24,3	25,4	26,4	27,2
cv-value	0,94	1,46	2,20	3,18	4,42	5,97	7,82	9,99	12,5	15,2	18,3	21,9	24,6	26,7	28,4	29,7	30,9	31,8

Pre-setting	4,6	4,8	5,0	5,2	5,4	5,6	5,8	6,0	6,2	6,4	6,6	6,8	7,0	7,2	7,4	7,6	7,9 = open
k_v-value	28,0	28,8	29,5	30,2	31,0	31,7	32,4	33,0	33,6	34,1	34,6	35,0	35,4	35,8	36,2	36,8	k _{vs} = 38,0
cv-value	32,8	33,7	34,5	35,3	36,3	37,1	37,9	38,6	39,3	39,9	40,5	41,0	41,4	41,9	42,4	43,1	44,5

Flow Data DN65

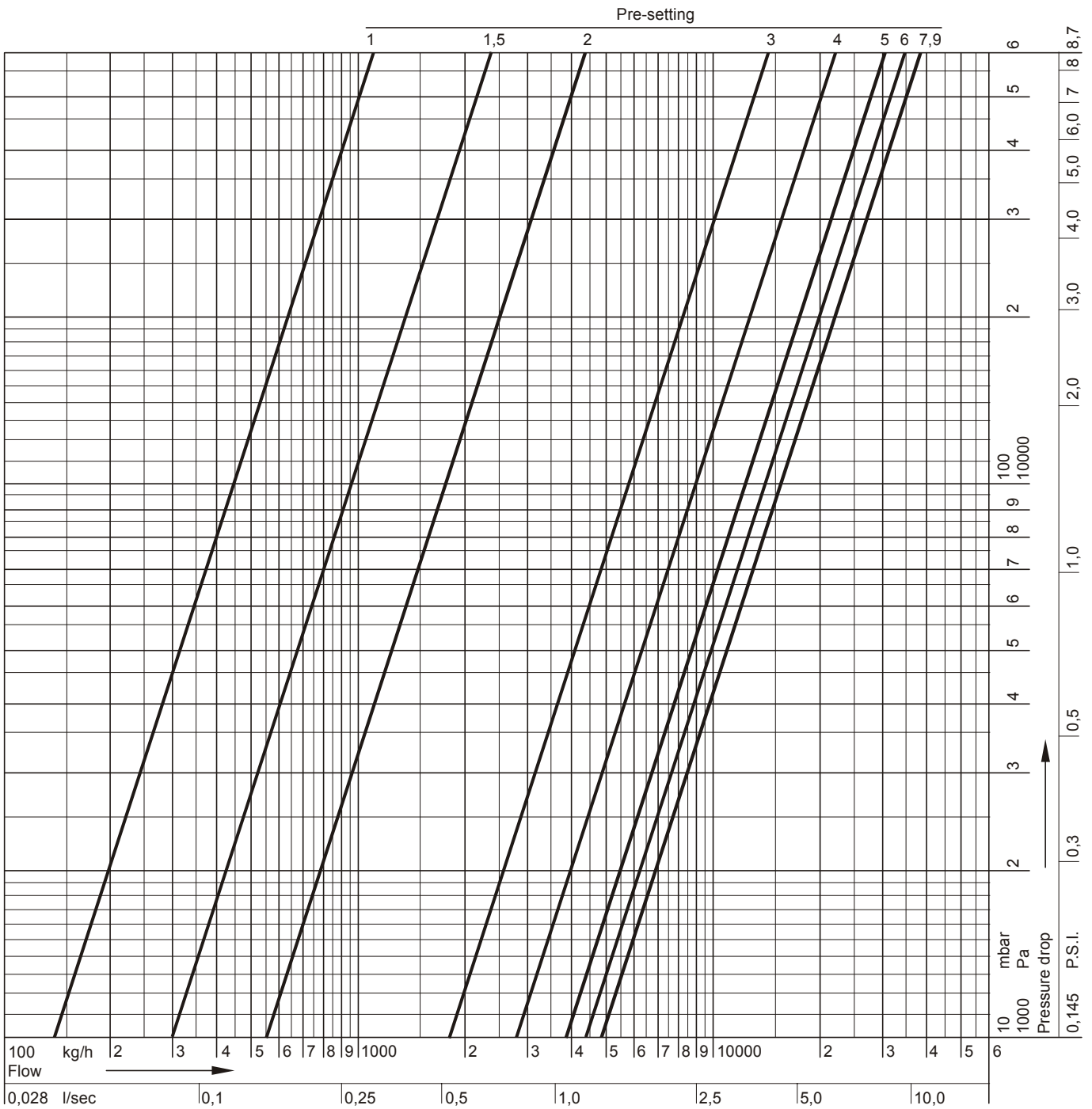

Pre-setting	1,0	1,2	1,4	1,6	1,8	2,0	2,2	2,4	2,6	2,8	3,0	3,2	3,4	3,6	3,8	4,0	4,2	4,4
k_v-value	1,40	1,50	2,50	3,50	4,50	5,50	7,70	10,0	12,2	14,5	16,7	19,0	21,3	23,7	26,0	28,3	30,1	31,9
cv-value	1,64	1,76	2,93	4,10	5,27	6,44	9,01	11,7	14,3	17,0	19,5	22,2	24,9	27,7	30,4	33,1	35,2	37,3

Pre-setting	4,6	4,8	5,0	5,2	5,4	5,6	5,8	6,0	6,2	6,4	6,6	6,8	7,0	7,2	7,4	7,6	7,9 = open
k_v-value	33,6	35,4	37,2	38,6	40,1	41,5	43,0	44,0	44,9	45,4	46,0	46,5	47,0	47,1	47,3	47,4	k _{vs} = 47,7
cv-value	39,3	41,4	43,5	45,2	46,9	48,6	50,3	51,5	52,5	53,1	53,8	54,4	55,0	55,0	55,3	55,5	55,8

Flow Data DN80

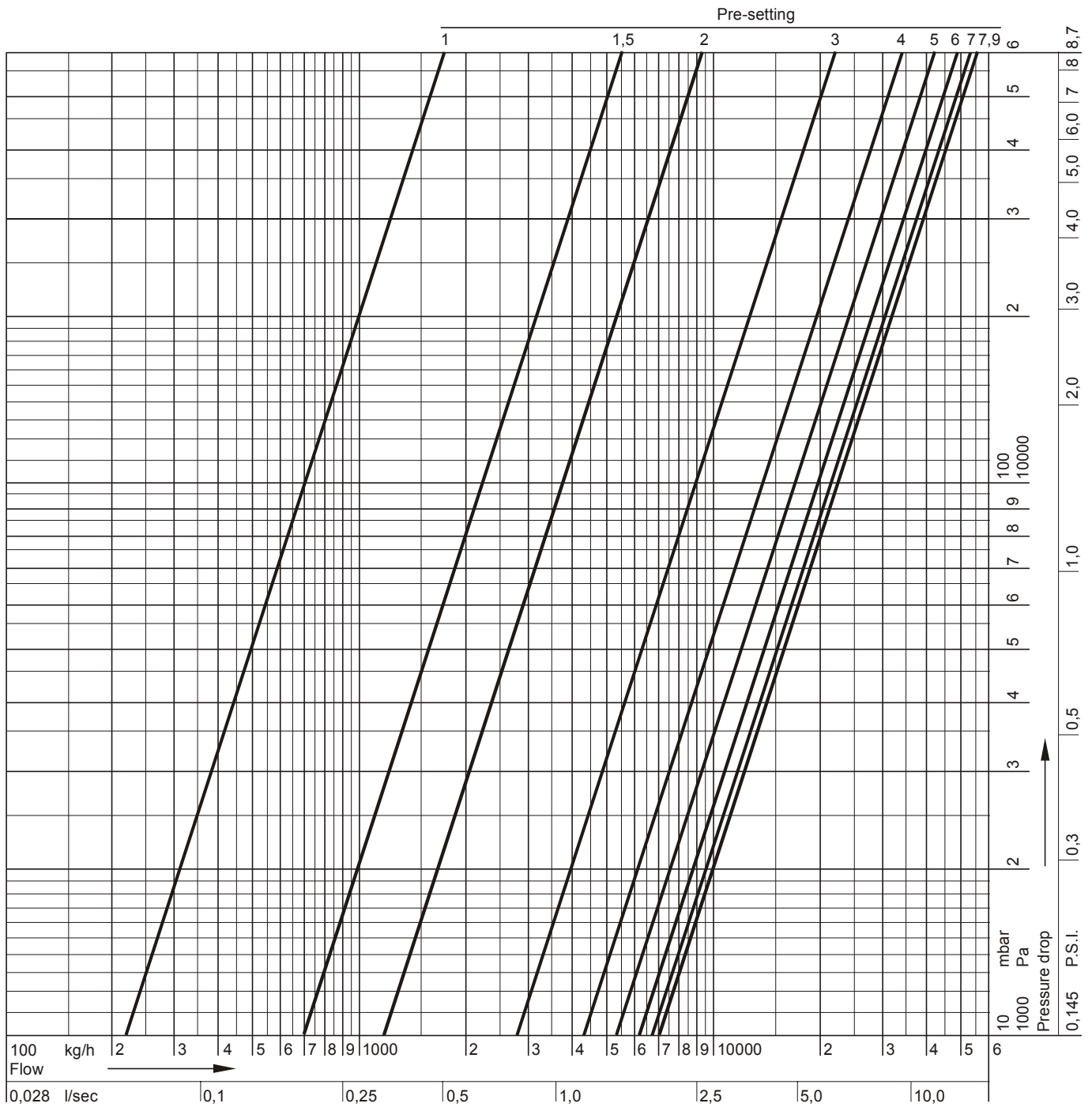

Pre-setting	1,0	1,2	1,4	1,6	1,8	2,0	2,2	2,4	2,6	2,8	3,0	3,2	3,4	3,6	3,8	4,0	4,2	4,4
k_v-value	2,20	4,20	6,20	8,10	10,1	12,1	15,3	18,5	21,6	24,8	28,0	30,9	33,9	36,8	39,8	42,7	44,9	47,0
k_v-value	2,57	4,91	7,25	9,48	11,8	14,2	17,9	21,6	25,3	29,0	32,8	36,1	39,7	43,1	46,6	50,0	52,5	55,0

Pre-setting	4,6	4,8	5,0	5,2	5,4	5,6	5,8	6,0	6,2	6,4	6,6	6,8	7,0	7,2	7,4	7,6	7,9 = open
k_v-value	49,2	51,3	53,5	55,2	57,0	58,7	60,5	62,2	63,4	64,5	65,7	66,8	68,0	68,6	69,2	69,8	k _{vs} = 71,0
k_v-value	57,6	60,0	62,6	64,6	66,7	68,7	70,8	72,8	74,2	75,5	76,9	78,2	79,6	80,3	81,0	81,7	83,1

Influence of Coolants on Flow Values

The flow through a valve is defined by the k_v -value. The k_v -value is the flow m through a valve in [m³/h] at a differential pressure of 1 bar (14,5 psi) and is only valid for fluids with a density of $\rho_0 = 1000 \text{ kg/m}^3$. This condition is met by water at a temperature of 20°C (68°F). For fluids with another density the following formula can be applied:

$$Kv_{Medium} = \frac{m}{\sqrt{\Delta p}} \times \frac{\sqrt{\rho_{Medium}}}{\sqrt{\rho_0}}$$

Correction Factor f

When the density σ is expressed in t/m³ instead of kg/m³ the correction factor f is the result. The correction factor f can be used to re-calculate k_v -value, pressure drop and flow:

$$Kv_{Medium} = Kv_0 \times \frac{1}{\sqrt{f}} \quad \Delta p_{Medium} = \Delta p_0 \times f \quad m_{Medium} = m_0 \times \frac{1}{\sqrt{f}}$$

Table 1. Values for correction factor f

Medium	water part	Correction factor f					
		5°C (41°F)	20°C (68°F)	35°C (95°F)	50°C (122°F)	65°C (149°F)	80°C (176°F)
Normal water	100%	1,000	0,998	0,994	0,988	0,981	0,972
Ethylen glycol	70%	1,052	1,047	1,041	1,033	1,024	1,015
e.g. Antifrogen N	50%	1,086	1,079	1,070	1,061	1,052	1,042
Propylen glycol	70%	1,035	1,029	1,021	1,012	1,002	0,991
e.g. Antifrogen L	50%	1,053	1,044	1,035	1,025	1,014	1,002

Honeywell

Control Products

Honeywell AG
Zu den Ruhrwiesen 3
D-59755 Arnsberg-Neheim

Phone: (49) 2932 9880
Fax: (49) 2932 988239
mng@honeywell.com

<http://europe.hbc.honeywell.com>